

TEAM SPORTS AND PARK & REC EQUIPMENT

VOLLEYBALL

FOOTBALL

A GOAL FOR EVERY GAME

LACROSSE

PADDLING

SOCCER

ERBALL

NETBALL
BASKETBALL
SOFTBALL
BASEBALL



2022-23

800-247-7668
www.bisoninc.com





PRODUCT CATEGORY INDEX



Bison and IPI are proud to be Official Corporate Partners of the National High School Federation, the governing body of all high school sports and activities. Bison has a long history of partnering with NFHS dating back over 25 years. Our partnership not only confirms our commitment to safe and durable team sports equipment that meets or exceeds all NFHS rules but also helps financially support the mission of the NFHS and its state member associations across the US.

Quick View Index

- Backboard Dimensions 84-85, 92
- Badminton 59
- Ball & Equipment Carts 26, 51, 59
- Competition Basketball 4-16, 20-24
- Competition Soccer 62-68
- Competition Volleyball 38-58
- Court & Field Diagrams 92-93
- Custom Graphics, Lettering & Logos 9, 26-36, 52, 69, 95
- Divider Curtains & Nets 17
- Field Hockey 70
- Football 67, 69
- Futsal 71
- Gym Construction & Renovations 3, 13-24
- Lacrosse 70
- Model Number Index 96-98
- Multi-Game Bases & Standards 12
- Outdoor Basketball 75-88
- Outdoor Volleyball 57-58
- Pickleball 61
- Portable Basketball Systems 4-12, 76
- Portable Soccer Goals 62-67
- Portable Volleyball Standards 47-50
- Residential Basketball 89-91
- Scorers & Activity Tables 28-31
- Seating 31, 72-74
- Team Handball 71
- Tennis 60
- Tetherball 59
- Wall Mounted Basketball Systems 13-16, 18-19
- Wall Padding (Indoor & Outdoor) 32-37
- Warranty & Return Policies 94
- Youth Basketball 12, 25, 76



INDOOR BASKETBALL 4 - 25



SCORERS TABLES 28 - 31



SAFETY PADDING & GRAPHICS ..32 - 37



VOLLEYBALL & NET GAMES38 - 61



SOCCER & FIELD SPORTS62 - 71



BLEACHERS & BENCHES72 - 74



OUTDOOR BASKETBALL75 - 88



RESIDENTIAL BASKETBALL89 - 91



800-247-7668
www.bisoninc.com



National Recreation and Park Association





Bison's IPI division serves the gym construction and renovation market through a separate network of professional, experienced regional dealers who can assess your needs, specify the right equipment and provide quality and safe installation and after the sale inspections and service.

IPI dealers provide only quality Bison gym equipment that is designed for safety, durability and superior elite competition play. When you have needs for installed wall or ceiling suspended basketball systems, divider curtains, wall padding, volleyball systems or other gym equipment, you can count on IPI.

Facility Owners, Architects and Contractors

Full product specifications for all IPI by Bison products are available online at www.IPIbyBison.com. Call **800-637-7968** for the name of an IPI dealer in your area.

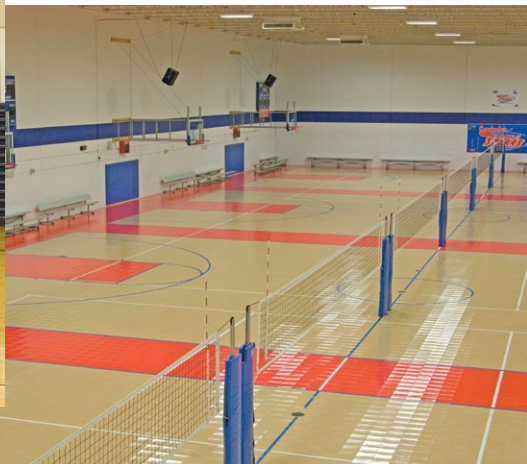

800-247-7668



www.bisoninc.com

Bison now offers a T-Rex portable basketball system for every level of play from elite level, FIBA sanctioned international to intramural and recreational play. All T-Rex portables feature industry leading extension spring counterbalance technology making raising, lowering and storage simple, safe and fast. All pivot locations operate freely on zero maintenance, self-lubricating bearings and chrome plated steel pivot axels. Weight ballast is hidden from sight in a covered weight containment cell. Narrow profile uprights reduce visual interference for fans or media behind the base. Floor friendly 8" x 2" wide casters in a variety of configurations depending on the T-Rex model you select, make moving your T-Rex easy and worry free. All T-Rex portables, when in the transport position, will roll through any doorway that is at least 84" high and 78" wide. T-Rex International is approved for FIBA LEVEL 1 competition. T-Rex Americana and T-Rex Competition are approved for FIBA LEVEL 2 competition. T-Rex International and T-Rex Americana also meet all NCAA and NFHS equipment rules. T-Rex Competition meets all NFHS rules. See page 13 for FIBA Level 2 wall basketball systems and contact us for FIBA Level 2 ceiling suspended systems.



Shown with Optional Graphics

BA8910IG T-Rex® International

Some programs desire the added 32" of safe play area found on our T-Rex International. Whenever possible, with today's aggressive style of play, we recommend International for the added measure of player safety if court space and budget allows. Floor space limitations between the court end line and the end court bleachers or wall will determine if this T-Rex with a 10'8" safe play area is right for your program.

In addition to being approved for FIBA Level 1 play T-Rex International also meets all NCAA and NFHS equipment rules.

Approximately 400# of additional rear ballast and additional springs are designed to offset the additional 32" forward extension.

T-Rex International features the same premium glass backboard, 180° breakaway goal, backboard, beam and base padding, an automatic base control system and other features found on T-Rex Americana above.

All steel base components have a standard bright white powder coated finish but can be ordered in a wide array of colors at an additional cost. Request BAFIBA to obtain a FIBA certificate at no extra cost.

Forklift or dock required for delivery. Contact Bison for other off-loading options.



Note: T-Rex Americana and T-Rex International Portables usually require factory installation not included in price list. Cost depends on location, quantity and other factors. Call for a quote.

INTERNATIONAL GAME STATS	
Safe Play Area at 10'	128"
Glass Backboard Size	42" x 72"
Breakaway Rim	BA3180S
Beam Size	6" Sq.
Ballast Weight	1500#
Total Weight	3228#
Padded Base Dimension	52"(w) x 80"(l)
Total 8" (d) x 2" (w) Wheels	4 (F), 4 (R)
Stored Dimensions	76"(w) x 204"(l) x 83"(h)
Beam Padding	Included
Rear Hold Down	Included
Deadlock Device	Included
Backboard Padding	17 colors
Front Base Padding (16 colors)	4" Thick Premium Sewn
Base Color	Bright White
Front Levelers	Automatic
Floor Load Transport	386# (F); 421# (R)
Floor Load Playing	634# (F); 173# (R)
Min. Required Floor Space Outside Court	202"



FIBA
APPROVED EQUIPMENT

*CONSULT A BISON PRODUCT SPECIALIST FOR OPTIONAL MANUAL ABC SYSTEM IF SPACE AVAILABLE IS LESS THAN SHOWN.

LEVEL 1

BISON IS THE EXCLUSIVE NFHS PARTNER FOR THE SPORT OF BASKETBALL



Shown with Optional Graphics



BA898AG T-Rex® Americana

Americana™ offers all the features desired by most Division I college programs and meets or exceeds all NCAA and National High School Federation rules. **Americana** portables feature an 8' safe play area and our **Automatic Base Control System** that makes set up and transport as easy as **ABC**. Just "**A**" roll the unit to its predetermined location on the playing surface and raise the backboard into its playing position, "**B**" insure that the front locator pins are properly inserted into the floor and "**C**" attach the rear safety hold down system. Manual base control system also available when wall, bleachers or other obstacles are present at rear of base.

In addition to being approved for FIBA Level 2 play **T-Rex Americana** also meets all NCAA and NFHS equipment rules.

Americana comes complete with a lifetime warranty official glass backboard, direct beam mount Baseline™ 180° breakaway goal, DuraSkin® backboard padding, high density vinyl upholstered base and beam padding, rear safety hold down system and a vibration deadening device to maximize system rigidity.

All steel base components have a standard bright white powder coated finish but can be ordered in a wide array of additional colors at an additional cost. **Request BAFIBA to obtain a FIBA certificate at no extra cost.**

AMERICANA GAME STATS	
Safe Play Area at 10'	96"
Glass Backboard Size	42" x 72"
Breakaway Rim	BA3180S
Beam Size	6" Sq.
Ballast Weight	1100#
Total Weight	2686#
Padded Base Dimension	52"(w) x 80"(l)
Total 8" (d) x 2" (w) Wheels	4 (F), 4 (R)
Stored Dimensions	76"(w) x 176"(l) x 83"(h)
Beam Padding	Included
Rear Hold Down	Included
Deadlock Device	Included
Backboard Padding	17 colors
Front Base Padding (16 colors)	4" Thick Premium Sewn
Base Color	Bright White
Front Levelers	Automatic
Floor Load Transport	330# (F); 342# (R)
Floor Load Playing	535# (F); 137# (R)
Min. Required Floor Space Outside Court	169**

Forklift or dock required for delivery. Contact Bison for other off-loading options.



Note: T-Rex Americana and T-Rex International Portables usually require factory installation not included in price list. Cost depends on location, quantity and other factors. Call for a quote.



FIBA APPROVED EQUIPMENT

***CONSULT A BISON PRODUCT SPECIALIST FOR OPTIONAL MANUAL ABC SYSTEM IF SPACE AVAILABLE IS LESS THAN SHOWN.**



Rear Hold Down Kit

LEVEL 2

Standard Features on T-Rex Americana & T-Rex International Portables



One Person Setup and Storage



Automatic Base Control System



Lowered For Play
Raised For Transport (2" Clearance)



Baseline™ 180° Breakaway



Vibration Dampening Device



800-247-7668



www.bisoninc.com



COMPETITION GAME STATS

Safe Play Area at 10'	96"
Glass Backboard Size	42" x 72"
Breakaway Rim	BA3180S
Beam Size	4" Sq.
Ballast Weight	1000#
Total Weight	2350#
Padded Base Dimension	40"(w) x 74"(l)
Total 8" (d) x 2" (w) Wheels	2 (F), 4 (R)
Stored Dimensions	76"(w) x 160"(l) x 78"(h)
Beam Padding	Included
Rear Hold Down	Included
Deadlock Device	Included
Backboard Padding	17 colors
Front Base Padding	2" Thick Sewn (16 colors) 4" on FIBA Models
Base Color	Bright White
Floor Load Transport	450# (F); 725# (R)
Floor Load Playing	700# (F); 475# (R)
Min. Required Floor Space Outside Court	130"

BA898G T-Rex® Competition

Budget conscious programs who still desire the 8' safe play area found on our T-Rex Americana but have limited space behind the court end line and limited budgets will find **T-Rex Competition** the perfect choice. **T-Rex Competition** meets all NFHS equipment rules.

Designed with many of the same features as our **Americana** and **International** portables, **Competition** raises for play and lowers for transport and storage with the same extension spring counterbalance technology as its big brothers.

While designed for value, the competition backboard, direct beam mount Baseline™ 180° breakaway goal and DuraSkin® backboard padding are identical to other models and guarantee rigid, durable and safe play year after year.

Competition is the perfect system for small programs, high schools, rec centers or side courts that require the safety of an 8' safe play area but at a value price. **Order BA898GFIBA for FIBA Level 2 Play.**

Forklift or dock required for delivery. Contact Bison for other off-loading options.



Shown with optional lettering and graphics



BA895G T-Rex® Side Court

For some programs, the 5½' safe play setback of **T-Rex Side Court** is a great solution. The shorter extension still allows durable, rigid play but requires less room for storage, less space outside the court end line and is a perfect practice or recreational portable.

T-Rex Side Court has most of the key design features of its larger T-Rex Competition unit including the same glass backboard, DuraSkin backboard padding and spring assist technology but the reduction in safe play area, the substitution of our traditional BA35S breakaway goal and making the vibration deadening device, beam padding and rear hold down kit optional make a standard **T-Rex Side Court** cost up to 10% less than **T-Rex Competition**.

SIDE COURT GAME STATS

Safe Play Area at 10'	66"
Glass Backboard Size	42" x 72"
Breakaway Rim	BA35S
Beam Size	4" Sq.
Ballast Weight	800#
Total Weight	1900#
Padded Base Dimension	40"(w) x 74"(l)
Total 8" (d) x 2" (w) Wheels	2 (F), 2 (R)
Stored Dimensions	76"(w) x 130"(l) x 78"(h)
Deadlock Device	Optional
Beam Padding	Included
Rear Hold Down	Optional
Backboard Padding	17 colors
Base Padding (16 colors)	2" Thick Sewn
Base Color	Bright White
Floor Load Transport	350# (F); 600# (R)
Floor Load Playing	575# (F); 375# (R)
Min. Required Floor Space Outside Court	100"



Shown with optional lettering

Bison's popular Competition™ and Side Court™ T-Rex Portables just got better. Lowering to playing position and preparing for transport is now just an ergonomic hand lever movement away. Removable handle lowers wheels for transport and retracts wheels for play with entire portable resting securely on front floor friendly feet.



Removable Lift Lever to Raise Lower Transport Wheels



Wheels Up Ready To Play



Wheels Down Ready To Roll

Other Features

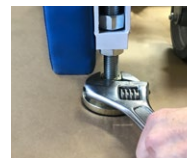

Initial Setup Front Leveling Pads



Baseline™ 180° Breakaway (Upgrade on BA895G)



Rear Hold Down Kit (Optional on BA895G)



Folds for Compact Storage



Deadlock Device (Optional on BA895G)



BISON IS THE EXCLUSIVE NFHS PARTNER FOR THE SPORT OF BASKETBALL



Forklift or dock required for delivery. Contact Bison for other off-loading options.



Shown with optional lettering

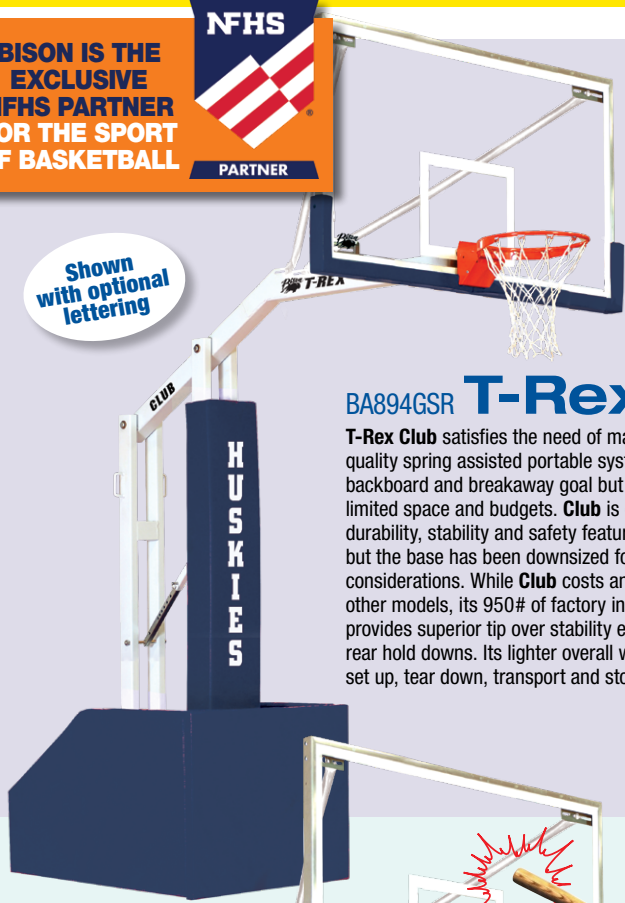

BA894GSR T-Rex® Club

T-Rex Club satisfies the need of many programs looking for a quality spring assisted portable system with a full size glass backboard and breakaway goal but are dealing with even more limited space and budgets. Club is designed to have many of the durability, stability and safety features of other T-Rex systems but the base has been downsized for space and cost considerations. While Club costs and weighs much less than other models, its 950# of factory installed hidden ballast still provides superior tip over stability even without use of optional rear hold downs. Its lighter overall weight and size allow easier set up, tear down, transport and storage.

CLUB GAME STATS

Safe Play Area at 10'	54"
Glass Backboard Size	42" x 72"
Breakaway Rim	BA35S
Beam Size	4" Sq.
Ballast Weight	950#
Total Weight	1700#
Padded Base Dimension	40"(w) x 65"(l)
Total 8" (d) x 2" (w) Wheels	2 (F), 2 (R)
Stored Dimensions	76"(w) x 124"(l) x 78"(h)
Beam Padding	Included
Rear Hold Down	Optional
Backboard Padding	17 colors
Base Padding (16 colors)	2" Thick Stapled
Base Color	Bright White
Front Levelers	Lead Screw
Floor Load Transport	N/A
Floor Load Playing	N/A
Min. Required Floor Space Outside Court	72"

Shown with optional lettering



BA894USR T-Rex® Recreational

T-Rex Recreational is identical to T-Rex Club above except the backboard is constructed of 1/2" thick clear, unbreakable polycarbonate instead of glass making it perfect for facilities where there is concern of vandalism or other activities that might threaten traditional tempered glass backboards. In addition, T-Rex Recreational comes with a locking device to eliminate unwanted and unsupervised raising and lowering of the basket.

If your program intends to use T-Rex Recreational outdoors, order BA894USRO for an outdoor version of T-Rex Recreational that substitutes Bison outdoor backboard padding and weather resistant pressure treated plywood for OSB board as backing for the base padding system. In addition, BA894USRO includes a security lock system to insure that the unit cannot be lowered and rolled from its installed location without authorization.

RECREATIONAL GAME STATS

Safe Play Area at 10'	54"
Polycarbonate Backboard Size	42" x 72"
Breakaway Rim	BA35S
Beam Size	4" Sq.
Ballast Weight	950#
Total Weight	1700#
Padded Base Dimension	40"(w) x 65"(l)
Total 8" (d) x 2" (w) Wheels	2 (F), 2 (R)
Stored Dimensions	76"(w) x 124"(l) x 78"(h)
Beam Padding	Included
Rear Hold Down	Optional
Backboard Padding	17 colors
Base Padding (16 colors)	2" Thick Stapled
Base Color	Bright White
Front Levelers	Lead Screw
Floor Load Transport	N/A
Floor Load Playing	N/A
Min. Required Floor Space Outside Court	72"

Forklift or dock required for delivery. Contact Bison for other off-loading options.



Standard Features on T-Rex Club & T-Rex Recreational Portables



Hidden Ballast Compartment



Ratchet Style Front Foot Leveling



Folds For Easy Storage



Play at Lower Rim Heights



Unbreakable Polycarbonate Backboard (BA894USR, BA894USRO only)



800-247-7668



www.bisoninc.com



Shown with Optional ABC50 Logo

BA893G T-Rex® Sport

T-Rex Sport...is the perfect blend of spring assisted counterbalanced technology, and easy rim height adjustment from 10' down to 7½'. Unlike other spring assist portables that move the backboard closer to the base when the rim is lowered, T-Rex Sport allows rim height adjustment while the base is in the play position without significantly sacrificing safe play area under the basketball when young players are using at lowered rim heights. The base is fully padded with 2" thick polyurethane foam on sides and on the front to a height of 72".

At official 10' rim height, the approximate safe play area is 50" and 42" at 7½'. When lowered for transport and storage, the total storage height is 76" to fit through most storage room double doors or garage doors.

Choose from 36" x 60" clear glass, 36" x 60" smoked glass, or 36" x 60" clear unbreakable polycarbonate backboard.

Base padding is covered with 16-ounce black leather grain vinyl, but can be ordered in other colors (see page 95) at an additional cost using **BA853UP** for orders of 2 or more.

Rear enclosed ballast box contains twenty 4" x 8" x 16" solid cap blocks (customer supplied).



One Person Setup

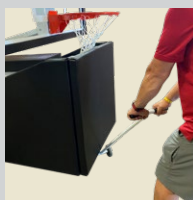

Easy To Use Transport Dolly

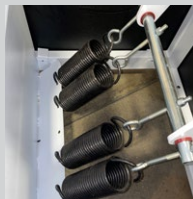

Proven Counterbalance Spring Technology

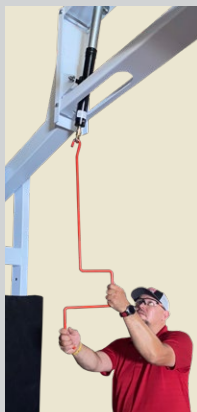

Smooth Rim Height Adjustment

SPORT GAME STATS	
Safe Play Area at 10'	50"
Backboard Size	36" x 60"
Backboard Options	Clear Tempered Glass BA893G Smoked Tempered Glass BA8935M Unbreakable Clear Polycarbonate BA893U
Breakaway Rim	BA32
Beam Size	4" Sq.
Ballast Weight	660#
Total Weight	1510#
Padded Base Dimension	42"(w) x 51"(l)
Stored Dimensions	62"(w) x 112"(l) x 76"(h)
Backboard Padding	Included
Base Padding	2" Thick Polyurethane with Black 16oz. Vinyl Cover (other colors available at an additional charge)
Base Color	Bright White
Min. Required Floor Space Outside Court	98"



BA890P ZipCrank Height Adjuster for T-Rex® Portables

Increase your T-Rex portable rim height flexibility with the addition of a Zip Crank Goal Height Adjuster system...Do you wish you didn't need to lose safe play area under the basket as you lower your rim on your spring counterbalanced parallelogram design portables? Now you can adjust rim height on any T-Rex Competition (BA898G) or T-Rex Side Court (BA895G) from 7½' to 10' without major loss of distance from the face of the backboard to the front of the base.

Rim height is easily adjusted straight up and down with an awning style hand crank.

This feature is perfect for facilities that regularly need lowered rim heights for young players, but that don't want to sacrifice safe play common with most portables.

BA890P must be added at time of order and can not be retrofitted to existing portables.



BISON IS THE EXCLUSIVE NFHS PARTNER FOR THE SPORT OF BASKETBALL



Full Color Graphics

Your T-Rex portable basketball systems (or your Arena Portable volleyball systems) can be not only highly functional, they can also promote team and school spirit, promote a sponsor, or inspire team greatness, with Bison full color printed graphic padding options.

There is no limit to the creative designs that can be added to front and side protective base padding. Add ABC50 to your order for full color graphics.

Bison's talented art staff can work from your rough concept, from your finished artwork, or provide you ideas to choose from.

Once design is finalized, Bison's 6 color ultraviolet ink cure process will create a vivid and durable image that won't peel, crack, or fade, even after years of indoor use.



Design



Print

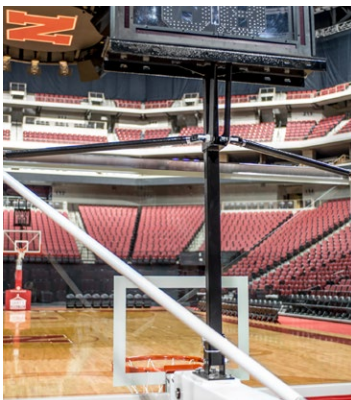

SCBKT2 Folding Shot Clock Bracket

This sturdy bracket is specifically designed to allow installation of beam mounted shot clock brackets on T-Rex portables • Folds to the rear to allow passage through doorways and halls when T-Rex is collapsed for storage in off season.



SCBKT6 Rear Shot Clock Bracket

Two-sided rear shot clocks have gained in popularity...this bracket will mount most rear shot clocks to most manufacturers' portables • Easy angle adjustment • May require minor field modification on some portables or with some rear shot clocks • Five-year limited warranty.



BA898GDL Optional Deadlock Tensioning Device

Add stability to BA895G T-Rex Portables with the inclusion of this optional feature • One required per goal • Standard feature on BA898G, BA898AG and BA8910IG portables.

BA898HD Optional Rear Hold-Down Kit

For all T-Rex portables...Meets NCAA and High School Federation rules requiring rear floor attachment for competition portable goals • Kit includes threaded floor anchor, eyebolt and turnbuckle to attach to built-in eye on rear of all T-Rex portables • Included standard with T-Rex Competition, Americana and International portables • Adds a measure of stability and safety • One required per goal.



New!



SHCLK200 Wireless Shot Clock System

Coming to a High School near you...In April 2021, the Basketball Rules Committee of the National Federation of State High School Associations, authorized State Associations to adapt 35 second shot clock usage beginning in the 2022-2023 seasons. Shot clocks have long been standard in NBA, Collegiate, and International competition.

Bison's stand-alone wireless shot clocks require no expensive wiring, just 110-volt outlets for each clock and controller. The controller sends the wireless signal from the scorer's table to the clock's mounted on backboard structures, walls, or free-standing pedestals on the floor. These wireless units do not interface with the scoreboard and are operated independently.

12" high bright red LED countdown numerals are built into a sturdy 19" wide x 15" high black sheet metal cabinet with integrated antennae. The operator control panel is compact, easy to operate and intuitive for accurate and dependable shot clock management with minimal operator training.

SHCLK200 is intended for high school use but could be used for other levels of play as the control panel comes factory preset at 35 second countdown but can be reprogrammed in the field to meet other shot clock timing requirements.

A shot clock reset button is factory set at the NFHS recommended 20-second reset for kicked ball or other reset rules but cannot be reprogrammed to other reset times.

System includes two shot clocks, control panel, integrated antennae and 30' 110 volt extension plugs for each. No special wiring is required.



800-247-7668



www.bisoninc.com

Max™ Portable Basketball Systems

Maximum versatility, maximum safety, maximum playability and maximum value......makes one of our Max portable systems just right for your facility • Choose **Super Max** with 60" tempered glass backboard and 50" safe play area, **Glass Max** with 54" tempered glass backboard and 30" safe play area or **Acrylic Max™** with 48" acrylic backboard and 30" safe play area.

No matter which Max you choose, you'll get features not found on similar systems offered by other manufacturers including:

- Infinite Goal Height Adjustment from 5' to Official 10'
- Durable Breakaway Goals
- Black Front Base and Pole Padding. Other Colors Available on Orders of 2 or more at an Additional Cost using **BA853UP**. (see page 95)
- Over 850# of Hidden, Customer Supplied Ballast to Eliminate Tip Over Risk (see BA853BLST below)
- Ballast is Totally Enclosed and Safety Padded
- Single-Lever Lift Handle to Allow Easy Transport and Set Up
- Goal Mounts Through Backboard Directly to Structure to Eliminate Backboard Stress
- Non Marking Transport Wheels
- When Lowered, Fits through 78" High Double Doors for Storage
- Standard Black Backboard Edge Padding on Super Max and Glass Max

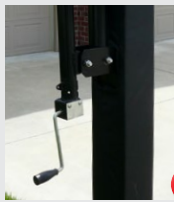

Smooth Operating Right Angle Crank

New!



Padded Weight Box Cover

Special liftgate delivery charge or extreme manual lifting required if dock/forklift not available.



BA853BLST Max™ Ballast Kit

Twenty-five 4" x 8" x 16" solid concrete cap blocks to properly eliminate tip over on all Max portable goals. Approx. 850#.

WARNING!

All Max systems require installation of 25 4" x 8" x 16" solid concrete cap blocks prior to use. The ballast tray and padded safety cover are designed specifically for use of the specified ballast. Failure to install the specified weight could result in serious player injury and invalidate all warranties. While the specified blocks are available at most lumber or home centers for a nominal cost, Bison can ship ballast package BA853BLST for an additional cost.

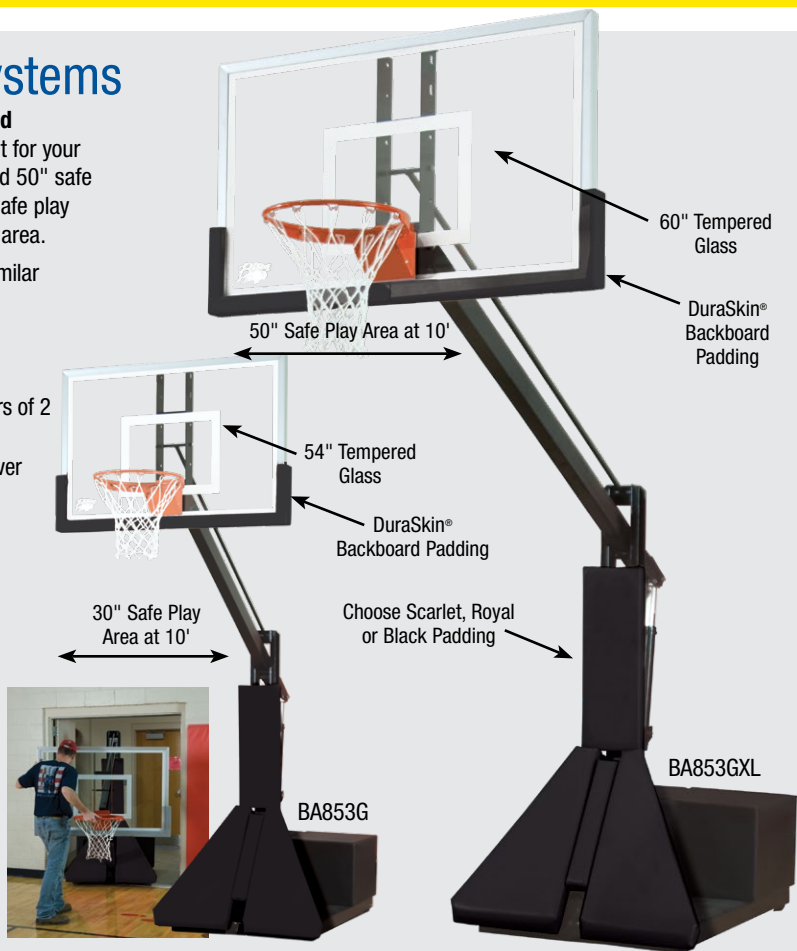

	BA853A Acrylic Max	BA853G Glass Max	BA853GXL Super Max
Backboard Size	32" x 48"	36" x 54"	36" x 60"
Backboard Type	Acrylic	Glass	Glass
Goal Type	BA29JR	BA32	BA32
Backboard Padding	N/A	Standard	Standard
Total System Weight (with ballast)	1400#	1450#	1550#
Customer Supplied Ballast Weight	850#	850#	850#
Padded Base Size	42" (w) x 50" (l)	42" (w) x 50" (l)	42" (w) x 50" (l)
Total Stored Dimensions	48" (w) x 128" (l) x 78" (h)	58" (w) x 128" (l) x 78" (h)	64" (w) x 139" (l) x 78" (h)
Setback at	10' - 30" 9' - 40" 8' - 48"	10' - 30" 9' - 40" 8' - 48"	10' - 50" 9' - 60" 8' - 68"
Lowest Playing Height	5'	5'	5'
Min. Required Floor Space Outside End Line	N/A	N/A	54"
Warranties			
Base	Five-Year Limited	Five-Year Limited	Five-Year Limited
Padding	Two-Year Limited	Two-Year Limited	Two-Year Limited
Goal	One-Year Limited	One-Year Limited	One-Year Limited
Backboard	Two-Year Limited	Ten-Year Limited	Ten-Year Limited

Portable Rear Hold-Down Kits

Additional stability...Add stability to any Bison Max portable system with these floor anchors and brackets.



BA800 For Concrete, Tile or Synthetic Floors

Kit includes two each of VB25 floor anchors and brackets...Requires core drilling into existing floors.

BA800FL For Floating Wood Floors

Kit includes two each of VB25FL floor anchors and brackets for floating floors...Requires core drilling and routing into existing floors.



Club Court™ Portable Basketball Systems

Choose **Super Glass Club Court** with 54" tempered glass backboard and 48" safe play area, **Acrylic Club Court** with 48" clear acrylic backboard and 36" safe play area, or **Graphite Club Court** with 48" molded graphite fan backboard and 36" safe play area.

All Club Court portables come standard with the following features:

- Spring Assisted Infinite Goal Height Adjustment from 6½' to Official 10'
- 1½" Thick, Black Padded Front Base and Riser
- Easy Flip Down Front Panel for Transport
- Fully Enclosed Oversized Ballast Enclosure to Hold Customer Supplied Ballast (see chart and BA833BLST below)
- Goal Mounts Directly to Extension Arm, Eliminating Stress on Backboard During Play
- Easily Folds Without Tools for Movement Through 78" High Double Doors
- Order ABC52 or ABC53 for Optional Front Pad Lettering (see page 95)
- Easy-to-Read Goal Height Indicator Labels
- Non Marking Transport Casters



	BA832 Graphite	BA833 Acrylic	BA833XL Super Glass
Backboard Size	36" x 48" Fan	32" x 48" Rectangle	36" x 54" Rectangle
Backboard Type	Molded Graphite	Acrylic	Glass
Goal Type	BA26	BA29JR	BA32
Total System Weight (with ballast)	840#	855#	1400#
Customer Supplied Ballast Weight	425#	425#	850#
Padded Base Size	29" (w) x 41" (l)	29" (w) x 41" (l)	34" (w) x 46" (l)
Total Stored Dimensions	48" (w) x 78" (l) x 78" (h)	48" (w) x 78" (l) x 78" (h)	54" (w) x 84" (l) x 78" (h)
Setback at	10' - 36" 9' - 32" 8' - 28"	10' - 36" 9' - 32" 8' - 28"	10' - 48" 9' - 44" 8' - 40"
Lowest Playing Height	6½'	6½'	6½'
Warranty			
Entire System	One-Year Limited	One-Year Limited	One-Year Limited

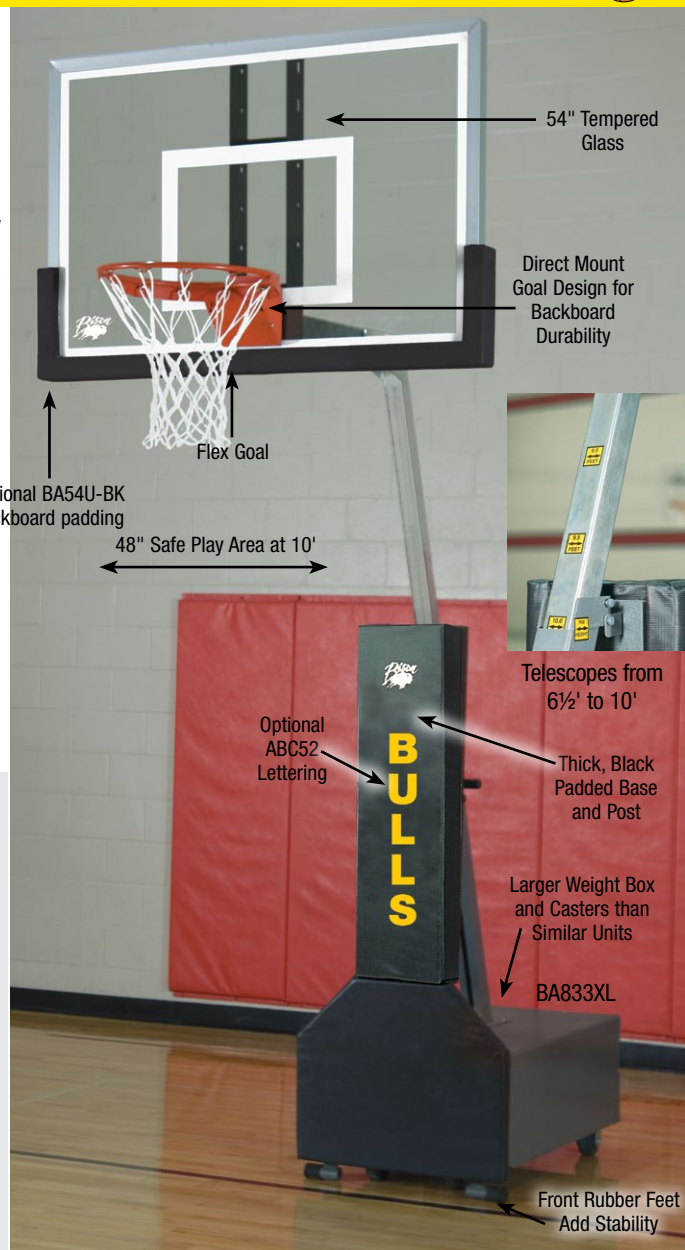

Special liftgate delivery charge or extreme manual lifting required if dock/forklift not available.



BA833BLST Club Court Ballast Kit

Approximately 425# of solid concrete cap blocks to properly eliminate tip over on all Club Court portable goals. Order one **BA833BLST** for each **BA832** and **BA833** • Order two for each **BA833XL**.

WARNING!

Club Court portables are designed for customer installation of solid concrete cap blocks prior to use. Failure to install the specified ballast could result in serious player injury and invalidation of all warranties. While specified blocks are available at most lumber or home centers for a nominal cost, Bison can ship ballast package BA833BLST for an additional cost.



800-247-7668



www.bisoninc.com

Playtime™ Elementary Portables

Playtime complete basketball standards roll in and out of the gym or multipurpose room with ease...Formed steel base provides sturdy foundation for tubular structure

- Telescoping structure easily adjusts goal height from 8' to 6½' in 6" increments
- White powder coated finish
- Choose 36" x 48" fan-shaped backboard of molded graphite or 32" x 48" rectangular backboard of clear acrylic
- Official size, 5/8" solid steel goal
- Playtime systems are for physical education, elementary school or shooting practice only and are not intended for aggressive competitive play
- **Safe Stuff structure padding included**
- Lower base trim protects your floor from damage
- Some assembly required
- Factory installed 100# ballast hidden in base.



Special liftgate delivery charge or extreme manual lifting required if dock/forklift not available.



Playtime	BA803	BA803A
Backboard Size	36" x 48"	32" x 48"
Backboard Type	Molded Graphite	Clear Acrylic
Goal Type	BA26	BA26
Total System Weight (with ballast)	330#	350#
Ballast Weight	Built-in	Built-in
Total Stored Dimensions	48" x 48" x 84"	48" x 48" x 84"
Lowest Playing Height	6½'	6½'
Warranty		
Entire System	One-Year Limited	One-Year Limited



PORTABLE GAME BASES AND ACCESSORIES

PB130 Portable Game Base



Indoors or outdoors, these portable weighted bases support a wide range of PE games...Use for volleyball, badminton, pickle ball, tennis, tetherball, paddle tennis, hoop games, jump rope or other creative games

- 24" diameter royal blue powder coated bases are factory weighted
- Durable non-marking wheels and molded urethane bottom ring protect floors during transport and use
- Includes 1¾" diameter x 10' galvanized steel upright
- Order nets, base padding and other accessories separately
- Includes one pair of game attachment collars
- One year limited warranty.



BM10N Badminton Net
Official 20' x 2½' size.



SVB08 Volleyball Net
Official 32' x 36" size with fluorescent top tape for maximum visibility.



PB100BP Base Padding

Improve safety with this specially designed pad that covers 360° around the PB130 portable game bases...1" thick foam with sewn cover in black vinyl

- Hook and loop attachment.

PB050 Universal Portable Base

Versatile portable base... This base can be used for a variety of purposes including low cost PE net games

- Base can be weighted with optional SC50B ballast bag
- 12" x 16" base has floor friendly feet
- Post is 60" high
- Net not included
- 90-day limited warranty.



PB150BB Basketball Accessory

Easy slip-on ring creates a goal for elementary shooting games...15" diameter ring with net hooks

- Adjusts to any height for thumbscrew tightening
- Ring and net only, order base with pole separately.

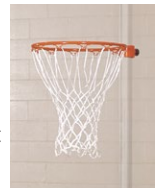



BISON IS THE EXCLUSIVE NFHS PARTNER FOR THE SPORT OF BASKETBALL



Stationary and Side Fold

Complete wall mount structure packages in-stock for immediate delivery.

CAUTION!
Wall structure purchaser assumes all mounting liability. SEE BACK PAGES OF CATALOG FOR SAFETY WARNING

Stationary

Structures adjust backboard face anywhere from 48" to 144" from wall at time of installation... Easy-to-order and install telescoping structures • Available for immediate delivery • Extra heavy steel tubular design with silver powder coated finish • Packages include structure, wall boards, support chains, Unbreakable 42" x 72" glass backboard, breakaway goal, DuraSkin backboard padding (choose from 17 colors), instructions and all mounting hardware except that required to anchor wall boards to wall • If you need rim height adjustability see page 14 for optional goal height adjusters • **Lifetime limited warranty on wall mount structures.**

Side Fold

Swing left or right for storage close to wall without tools or ladders... Structures position backboard face anywhere from 48" to 144" from wall at time of installation without field modification • Available for immediate delivery • Extra heavy, steel tubular design with silver powder coated finish • Heavy, solid steel, machined pivot bushings with 5/8" grade 5 pivot bolts (not just a hole drilled into tubing!) • Slotted mounting brackets for fine tuning goal height • Packages include structure, wall boards, support chains, Unbreakable 42" x 72" glass backboard, breakaway goal, DuraSkin backboard padding (choose from 17 colors), release hook, instructions and all mounting hardware except that required to anchor wall boards to wall • If you need rim height adjustability see page 14 for optional goal height adjusters • **Lifetime limited warranty on wall mount structures.**

IN-STOCK

Extra Heavy, Solid Steel, Machined Pivot Bushings with 5/8" Grade 5 Pivot Bolts on Side Fold Structures (not just a hole drilled into tubing!)

Superior Strength and Rigidity from 33% More Steel than Comparable Custom-Built Structures



Triple Set Screws and Fail-Safe Final Through Bolting Make Telescoping Components Stable and Secure

Heavy Wall, 2" Seamless Tubing

100% Welded Joints (no clamps to work loose!)

Prefinished 2" x 8" Timbers Pre-drilled and Ready for Mounting

Slotted Mounting Brackets for Fine Tuning Goal Height

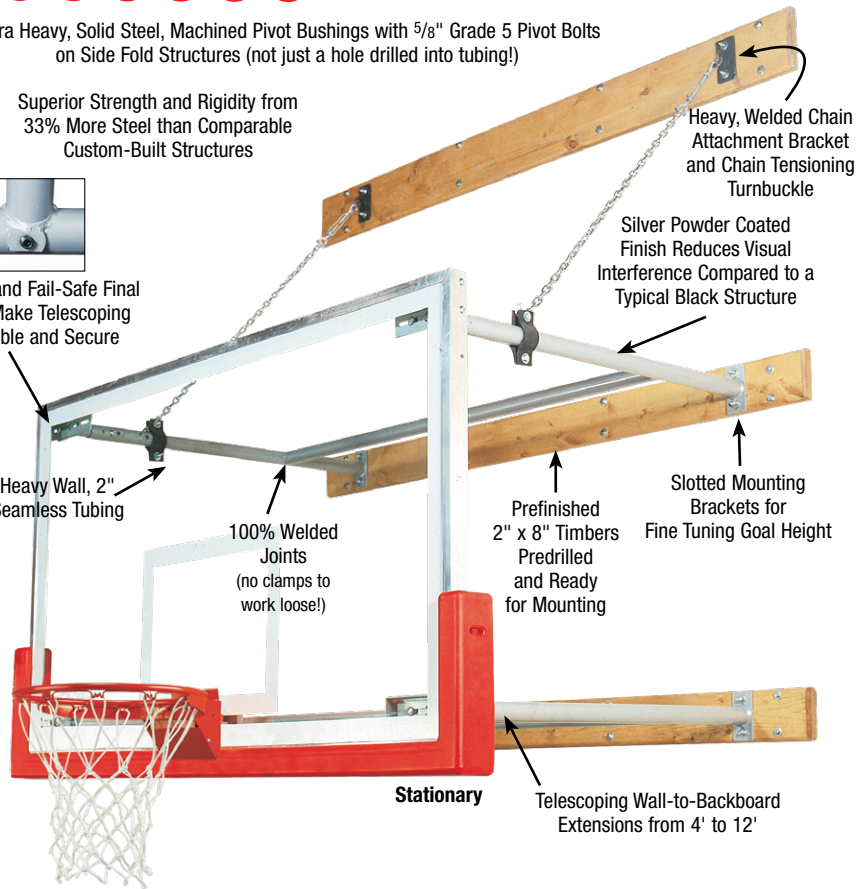

Stationary

Telescoping Wall-to-Backboard Extensions from 4' to 12'



Side Fold

Telescoping Structures for Fail-Safe Measuring...
There is no need to compute exact extension requirements before ordering wall mounted structures from Bison. Our structures are specially designed to allow adjustment within a specified range at installation. You'll also avoid costly field modifications caused by measurement mistakes.

Package Model #	Wall-to-Backboard Extension Range	Components Included
STATIONARY		
PKG46STRG	48" to 72"	BA42XL Official Unbreakable Short Glass Rectangular Competition Backboard, BA35S ProTech Competition Breakaway Goal, BA68U DuraSkin Padding
PKG68STRG	72" to 96"	BA42XL Official Unbreakable Short Glass Rectangular Competition Backboard, BA35S ProTech Competition Breakaway Goal, BA68U DuraSkin Padding
PKG82STRG	96" to 144"	BA42XL Official Unbreakable Short Glass Rectangular Competition Backboard, BA35S ProTech Competition Breakaway Goal, BA68U DuraSkin Padding
SIDE FOLD		
PKG46SFRG	48" to 72"	BA42XL Official Unbreakable Short Glass Rectangular Competition Backboard, BA35S ProTech Competition Breakaway Goal, BA68U DuraSkin Padding
PKG68SFRG	72" to 96"	BA42XL Official Unbreakable Short Glass Rectangular Competition Backboard, BA35S ProTech Competition Breakaway Goal, BA68U DuraSkin Padding
PKG82SFRG	96" to 144"	BA42XL Official Unbreakable Short Glass Rectangular Competition Backboard, BA35S ProTech Competition Breakaway Goal, BA68U DuraSkin Padding

See [YouTube.com/bisoninc](https://www.youtube.com/bisoninc) for Product Videos



SHOWN



BISON STATIONARY AND SIDE FOLD UNITS ARE APPROVED FOR FIBA LEVEL 2 PLAY UP TO A 89" EXTENSION FROM THE WALL. ADD BAFIBA TO ORDER AT NO EXTRA COST TO COMPLY.



800-247-7668



www.bisoninc.com

ZipCrank™ Goal Height Adjusters

From adult to youth play in 60 seconds... ZipCrank corner mount rim height adjusters are designed to avoid reduced backboard and rim rigidity common with other height adjustable goal systems • Movable framework slides up and down on two chrome plated 1" diameter rods riding in machined steel bushings • Height adjusters are installed between the backboard and the backboard support structure and when retrofitted on existing courts moves face of backboard 3/4" toward the free throw line • May require minor field drilling on some existing retrofit applications • Adjusts rim infinitely from official 10' to 8' heights and includes easy-to-read height indicator labels • Manual models are operated with the hand crank provided or with optional **BA931** Cordless Winch Winder • Electric models operate with hard wired wall mounted **BA975KS** Wall Mounted Key Switch • See chart below for ordering details including use on center strut structures • Five-year limited warranty.



Backboard Type	Manual Operation	Electric Key Switch Operation
42" x 72" backboard with 4 corner mounts	BA980RS	BA980RSE
48" x 72" backboard with 4 corner mounts	BA980RT	BA980RTE
Fan shaped backboard	BA980F	N/A
Other backboards with approximate 35" (w) x 20" rear mounting patterns	BA980F	N/A
Backboards that mount to single 6" or 6 ^{5/8} " diameter support structures	See page 15 for adapters and consult a Bison Product Specialist	
Backboards on certain T-Rex portable backstops See page 8 for details	BA980P	N/A

Electric Actuator



Operation Options



Standard Manual Crank Operation



Optional BA931 Cordless Winch Winder Operation

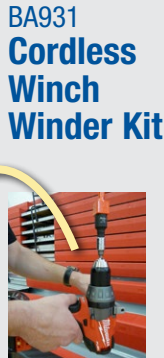

**BA931
Cordless
Winch
Winder Kit**



Optional BA975KS Electric Key Switch Operation

Standard Manual Crank Operation

Each ZipCrank Height Adjuster is supplied with one manual adjustment rod that allows easy up and down operation from the gym floor.

BA931 Cordless Winch Winder Kit

Increase the ease and speed of adjusting Bison ZipCrank Goal Height Adjusters with this cordless, rechargeable winch winder • Kit includes cordless drill, battery charger, special 1/2" square drive adapter and BA935 extension drive rod.

BA975KS Electric Key Switch

Traditional key operated switch with cover... Up-Down labeled cover plates also available in 1, 2, 3, 4 and 6 gang box options. Call for details.



Gym Upgrade Packages

When it's time to upgrade your basketball court, Bison's Official Gym Upgrade Packages will save you money and guarantee single source compatibility...There is a package to fit your existing wall or ceiling mount structure regardless of manufacturer • All components are designed and built by Bison for guaranteed compatibility • Premium and standard upgrade packages available, all with backboard, goal and backboard padding • All packages contain one of each of the listed Bison basketball components • **Order two packages to upgrade both ends of the court.**



Package Description	Backboard		Goal		Padding		
	Model/Size	Warranty	Model	Warranty	Model	Warranty	Color
OFX423180 Official Premium 180° Short Board Upgrade Package	BA42XL 42" x 72"	Unconditional Lifetime	BA3180S	Four-Year Limited	BA68U	Ten-Year Replacement	17 Colors Please Specify
OFX4235E Official Premium Short Board Upgrade Package	BA42XL 42" x 72"	Unconditional Lifetime	BA35S	Three-Year Limited	BA68U	Ten-Year Replacement	17 Colors Please Specify
OFS4234 Official Standard Short Board Upgrade Package	BA42E 42" x 72"	Ten-Year Limited	BA34	One-Year Limited	BA68U	Ten-Year Replacement	17 Colors Please Specify
OFC4235E Official Premium Conversion Board Upgrade Package	BA42XLC 42" x 72" Conversion	Unconditional Lifetime	BA35S	Three-Year Limited	BA68U	Ten-Year Replacement	17 Colors Please Specify
OFC4234 Official Standard Conversion Board Upgrade Package	BA42XLC 42" x 72" Conversion	Unconditional Lifetime	BA34	One-Year Limited	BA68U	Ten-Year Replacement	17 Colors Please Specify
OFX483180 Official Premium 180° Tall Board Upgrade Package	BA48XL 48" x 72"	Unconditional Lifetime	BA3180T	Two-Year Limited	BA68U	Ten-Year Replacement	17 Colors Please Specify
OFX4835E Official Premium Tall Board Upgrade Package	BA48XL 48" x 72"	Unconditional Lifetime	BA35E	Five-Year Limited	BA68U	Ten-Year Replacement	17 Colors Please Specify
OFS4834 Official Standard Tall Board Upgrade Package	BA48 48" x 72"	Ten-Year Limited	BA34	One-Year Limited	BA68U	Ten-Year Replacement	17 Colors Please Specify

Center Strut Backboard and Height Adjuster Adapters

If your existing center strut ceiling mount structure is not designed to mount to backboard corners...these adapters allow installation of Bison backboards and/or ZipCrank height adjusters to your existing center strut structures • **Caution! May reposition face of backboard in relationship to court lines** • Select from the chart below.

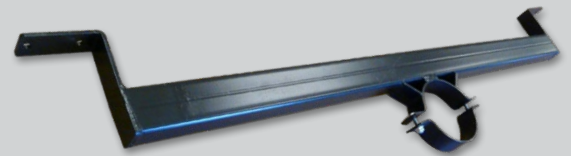

Model #	Center Strut Diameter	Backboard Mounting Pattern
BA600YF	6"	35" (w) x 20" (h) (fan)
BA600YR	6"	62" (w) x 36" (h) or 62" (w) x 42" (h)
BA658YF	6 5/8"	35" (w) x 20" (h) (fan)
BA658YR	6 5/8"	62" (w) x 36" (h) or 62" (w) x 42" (h)



800-247-7668



www.bisoninc.com



OFTEN IMITATED – NEVER EQUALED



BISON'S ORIGINAL DURASKIN

BA68U DuraSkin® Indoor Backboard Padding

Are you old enough to remember when no one could jump high enough to contact the bottom of the backboard? Do you remember the old glue-on gray foam padding that constantly needed repair or reattachment with duct tape or replacement? If so, you also may remember that Bison revolutionized backboard safety padding in 1990 when it first introduced durable, bolt-on DuraSkin padding, now available in industry leading 17 colors.

DuraSkin mounts to all 72" wide glass backboards regardless of manufacturer with eight 1/4" bolts and its thick skin, durable inner foam and molded in steel inserts allow Bison to offer an industry leading **ten-year unlimited warranty**.

While other manufacturers have tried to copy DuraSkin, it remains the standard in the industry with over 150,000 sets sold since its 1990 introduction.

	Black		Columbia Blue		Vegas Gold
	Kelly Green		Maroon		Cardinal
	Scarlet		Gold		Brown
	Royal		Gray		Burnt Orange
	Orange		Purple		Pink
	Forest Green		Navy		

Actual colors are not guaranteed to match printed catalog images.

BA950LR Gym Overhead Aut-O-Loc™ Safety Belt

Protect fans, players, floors and bleachers from damage if any overhead apparatus fails due to improper installation, maintenance or other failures... Use on ceiling suspended basketball or volleyball systems, wrestling mats, batting cages or any equipment that could cause injury or damage • Also commonly used on wall mounted basketball systems • Required in some states and in some circumstances by NCAA rules • Each BA950LR includes mounting clamps to connect to 3 1/2" outside diameter ceiling supported structure and comes with retractable 34' of safety belt attached to equipment structure • Patented single use design improves safety by eliminating the reuse of a unit that has been activated by a gym equipment attachment failure • Device prevents equipment free fall by sensing both speed and acceleration engaging its catch mechanism only when it is serving its intended safety purpose • Operates much like an automotive seat belt • Recommended for 100% of the overhead equipment in every facility • Five-year limited warranty.



BA950LR



BA925LR



BA930

BA925LR Manual Backstop Winch

Many retractable swing up basketball backstop installations do not require electric backstop winches... BA925LR mounts to the wall and comes with an easy-to-operate hand crank with 3/4" square drive • Can easily be adapted to replace existing tired and difficult to operate manual winches • Can also be operated with optional BA930 Portable 110 Volt Hand Winch Driver • Order SUCBLFT 1/4" aircraft cable and any needed cable pulleys and brackets separately • Wood wall mount board included • Five-year limited warranty.

BA930 Portable 110 Volt Hand Winch Driver

Makes raising and lowering manual crank swing up structures faster and easier... 7 AMP, 1/2 HP high torque winch • Reversible up and down operation • Two speed motor • Includes both 1/2" (BA93250) and 3/4" (BA93275) square drive adapters to operate BA925LR manual winch or other manufacturers' manual winches • To use BA930 to operate Bison ZipCrank rim height adjusters, order BA935 Drive Shaft separately. • One-year limited warranty.

BA935 ZipCrank Height Adjuster Drive Shaft (not shown)

Order BA935 to raise and lower Bison ZipCrank Height Adjusters using BA930 or similar power tools • Includes BA93250 1/2" square drive adapter.



BA973LR BA974LR Electric Backstop Winches

Lightweight, but not lightweight when it comes to power, safety

and durability • 3/4 HP instantly reversible motor develops 1250# of cable lift at a speed of 9 feet per minute • 1/4" diameter, 7000# aircraft cable winds on a 4 1/2" diameter grooved aluminum drum • Hardened, positive locking, steel worm gears are designed with a 200:1 reduction to eliminate backlash and slippage common on belt driven winches • Additional features include easy to set limit switches, cable take up tension roller, UL listing and optional remote control operation • Includes key switch, cord and 110 volt plug • Order BA973LR for 3/4 HP Electric Backstop Winch or BA974LR for 1 HP Electric Backstop Winch • Order SUCBLFT for cut to length 1/4" aircraft cable.





DN1250 Portable Divider Net System

Separate courts for safe play without expensive ceiling mounted divider curtains...14' high, 50' long black mesh net has durable reinforced vinyl edges and stores in a zippered storage bag when not in use • Net is supported by two factory weighted bases with telescoping poles for easy set up and storage • So versatile it can be used in any indoor or outdoor location • Portable bases and posts can also be used for P.E. net games at any height, including volleyball, badminton and tennis with purchase of SVB08 recreational volleyball net • Extend the divider net in 50' increments with purchase of additional DN12 bases and DN50 nets • One-year limited warranty.

DN12 Divider Net System Adder Base

Extend divider net...Add bases and nets • Same weighted base and 12' telescoping net support pole as DN1250 system above.



DN50 14' x 50' Divider Net

Add additional nets...Extend divider system • 3 ply, 1¾" square mesh • Includes zippered storage bag and pole attachment hardware.

DN25 Outdoor 12' x 25' Netting

1" square, 4mm knotless woven mesh...Heavy side, top and bottom tapes • Brass grommets for attaching to posts, cables, fencing • Netting only.



DN25

BA801BP Portable Base Padding

Improve player safety...Specially designed pad that covers 360° around the divider net base • 1" thick foam with black vinyl sewn cover • Hook and loop attachment.



BA801BP





CAUTION!

Wall structure purchaser assumes all mounting liability. SEE BACK PAGES OF CATALOG FOR SAFETY WARNING

Bison Shooting Stations provide a wall mount system to match any budget and level of need. Prior to purchase, verify that your wall is suitable in construction, size and layout to support the package weight and stress from use.

Field Modifiable Wall Mounted Structure Packages

These complete kits provide all the necessary components (except wall mounting fasteners) to install a rigid, durable basketball system to the wall of your existing facility...Choose from 1'-4' or 4'-8' extensions and different backboard options shown in chart below. Cut and drill extension tubes at desired extension length • See page 16 for optional backboard padding and page 14 for optional goal height adjusters • 5-year warranty on structures.



PKG500

12" to 48" Safe Play Area

Package Model #	Wall to Backboard Extension Range	Backboard	Breakaway Goal	Optional Backboard Padding
PKG14STFS	12" to 48"	BA495 Fan Steel	BA32	N/A
PKG48STFS	48" to 96"	BA495 Fan Steel	BA32	N/A
PKG14STRG	12" to 48"	BA42XL 42" x 72" Glass	BA35S	BA68U
PKG48STRG	48" to 96"	BA42XL 42" x 72" Glass	BA35S	BA68U
PKG500	12" to 48"	BA407G 42" x 54" Glass	BA35S	BA54U-BK

PKG650 Adjustable Height Glass Shooting Station™

Tempered glass backboard...Same heavy-duty wall structure and wall mounting boards as PKG600 below except includes 54" x 42" unbreakable side court tempered glass backboard (BA407C) for competition look and ball rebound • Approximately 36" extension at 10' rim height • Adjustable from 8' to 10' • Official size breakaway goal (BA32) with one-year limited warranty • Ten-year limited warranty on structure • **Unconditional lifetime warranty on backboard.**

PKG675 Official Adjustable Height Glass Shooting Station (not shown)

Same structure and rim as PKG650 above but with official size 72" x 42" "Unbreakable" (BA42XLC) glass backboard • **Unconditional lifetime warranty on backboard.**

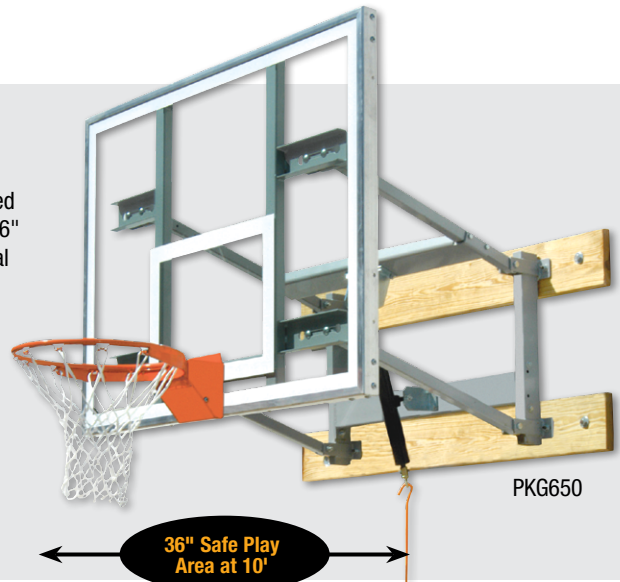

PKG650

36" Safe Play Area at 10'



PKG600

36" Safe Play Area at 10'

PKG600 Adjustable Height Steel Shooting Station™

Convenient, cost effective system for players of all ages...All the components necessary to mount a durable, playable, institutional quality fan-shaped steel backboard and official size institutional breakaway goal to a structure that will allow goal height adjustment from 10' to 8' • Removable hand crank allows easy adjustment without ladder • Safe play area is approximately 36" at official 10' goal height and 40" at 8' • Use of 2" x 8" wall boards for load spreading wall attachment is superior to similar systems where the steel is mounted directly to the wall • All steel structure is heavy gauge tube with a 1/8" minimum wall thickness and silver powder coated finish • All pivot points are 1/2" diameter • Customer provides wall mounting hardware • Ten-year limited warranty on backboard and structure • One-year limited warranty on goal.



CAUTION!

Wall structure purchaser assumes all mounting liability.
SEE BACK PAGES OF CATALOG FOR SAFETY WARNING

IN-STOCK SHOOTING STATION™ PACKAGES

When traditional competition wall structures are more than your facility requires, choose from fixed height or adjustable packages with steel, glass, molded graphite or acrylic backboard options.

PKG300 ZipCrank™ Adjustable Shooting Station™

Hand crank moves this 54" x 36" glass backboard with ease... Easy-to-operate removable hand crank adjusts goal height from official 10' to as low as 7½' for play by kids of all ages • Official size breakaway goal and direct goal mount design make backboard virtually unbreakable during normal play • Steel structure mounts to wall by means of three load spreading struts • Customer provides wall mounting anchors • Mounts indoors/outdoors • 30" safe play area at 10' • Five-year limited warranty on board and structure.

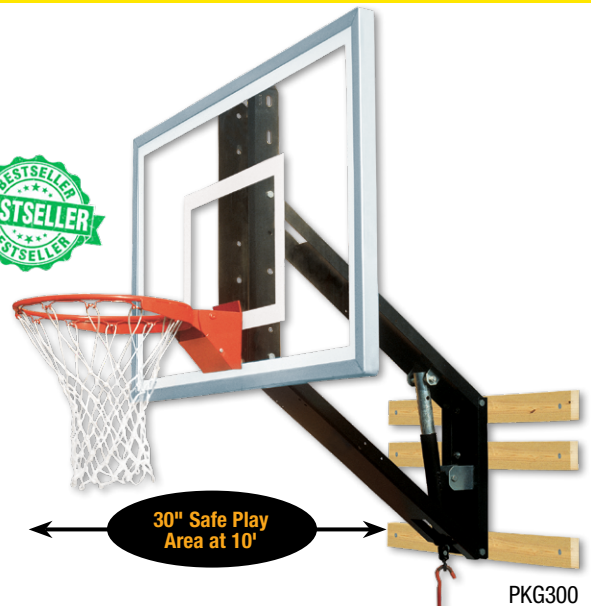

PKG275 QwikChange™ Acrylic Shooting Station™

For the look of a professional court at a budget price... Official size flex goal raises and lowers with ease on this system that features a 32" x 48" clear rectangular backboard • Direct mount goal design • No ladders or tools • 7½' to 10' goal height adjusts from the playing surface • Entire system mounts easily to the wall with two load spreading struts • Customer supplies suitable wall mounting hardware • Mounts indoors/outdoors • 22" safe play area at 10' • One-year limited warranty on system.



PKG250 QwikChange™ Graphite Shooting Station™

Our lowest cost adjustable wall mount system... Move the goal height from 7½' to 10' in 6" increments with a broom handle from the floor • 36" x 48" molded graphite fan-shaped backboard and official size flex goal are direct mounted to the steel structure for superior backboard durability • QwikChange structure is attached to wall with two struts to spread load on wall • Customer provides wall mounting anchors • Mount indoors/outdoors • 22" safe play area at 10' • One-year limited warranty on system.



800-247-7668



www.bisoninc.com

19



BA42XL



BA42XLC



BA48XL



BA48XLC

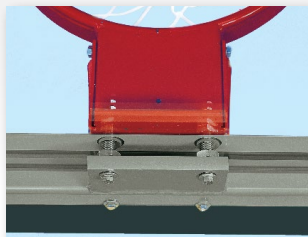

Rear Stabilizer Bar
Eliminates Stress on Glass

Unbreakable "XL" Glass Backboards

Built-in support structure absorbs over 98% of the stress from goal contact without transferring it to the glass...Goal is mounted "off glass" so even excessive hanging and abuse will not cause stress • Never again be concerned about the risk of injury or inconvenience of glass breakage • We are so confident of our "XL" design durability that for over five years we have offered a **\$250** installation reimbursement in addition to our **unconditional replacement warranty** without a single request for reimbursement • Every "XL" unbreakable backboard features a polished aluminum extrusion framework, glass cushioning gasket, high strength steel support structure, ½" tempered glass with fire impregnated bright white border and shooters square and **unconditional lifetime warranty** • All Bison glass backboards on this page are predrilled for quick installation of original DuraSkin backboard padding.

BA42XL 42" Short Unbreakable "XL" Glass Backboard

The 42" x 72" short board version of our "XL" backboard line...This backboard has the industry standard 35½" x 62" structure mounting design and 5" x 4" goal hole pattern to make upgrade retrofitting to any manufacturer's short board ceiling or wall mount structure foolproof

- **Unconditional lifetime warranty.**

BA48XL 48" Tall Unbreakable "XL" Glass Backboard

Same as BA42XL except 48" x 72" size...With 42" x 62" structure mounting pattern and 5" x 5" goal mounting pattern • Compatible with all manufacturer's tall board structures

- BA48XL is the only unbreakable 48" backboard in the industry and is the perfect solution to upgrading old traditional 48" glass boards that are now in use in thousands of gyms across the country

- **Unconditional lifetime warranty.**



BA42XLC 42" Short Unbreakable "XL" Glass Conversion Backboard

Make the transition...Go from old fan-shaped steel or glass backboards to popular 42" x 72" rectangular glass backboards normally without modification or relocation of your existing wall or ceiling support structures

- The 35" wide x 20" high rear structure mounting pattern is the standard in the industry for most fan-shaped gym backboards and structures
- **Unconditional lifetime warranty.**

BA48XLC 48" Tall Unbreakable "XL" Glass Conversion Backboard

This board is intended primarily for replacement of broken, existing 48" boards, mounted on fan style, wall or ceiling structures (35" x 20") common in older gyms...If you are replacing fan steel or glass backboards on both ends of a court, Bison recommends use of BA42XLC short backboards • Consult a Bison Product Specialist for selection of the right board for your application • **Unconditional lifetime warranty.**

Bison is confident you will never need to replace these boards – so confident that we offer a **\$250 installation reimbursement for any broken BA42XL, BA42XLC, BA48XL or BA48XLC backboard replaced under Bison's lifetime warranty!**

See back pages of Catalog for Backboard Drawings

CAUTION!

Studies have demonstrated that 42" x 72" glass backboards reduce the risk of player injury from backboard contact. BA42XL and BA42XLC are recommended for all new installations and fan-to-rectangle conversions. Bison makes 48" x 72" backboards (BA48, BA48XL and BA48XLC) available ONLY for replacement applications.



See back pages of catalog for
Backboard Drawings

OTHER GYMNASIUM BACKBOARDS



BA42E Standard 42" Short Backboard

Excellent value... Meets or exceeds all NCAA and National High School Federation rules

- Pre-drilled for original DuraSkin backboard padding
- 42" x 72" x 1/2" tempered glass with fire impregnated, bright white border and shooter's square
- Polished aluminum framework
- 36" x 62" structure and 5" x 4" rim mounting pattern
- 5-year limited warranty.

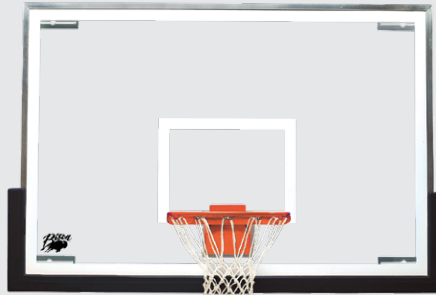

BA48 Standard 48" Tall Backboard

Traditional size, improved quality... This 48" x 72" board is a common fixture in gyms across the US and meets all appropriate rules for competition play

- Board features 42" x 62" structure mounting pattern and 5" x 5" goal mounting pattern and will replace virtually any manufacturer's original tall glass backboard
- 5-year limited warranty.



BA407C Side Court Conversion Glass

The most affordable glass option available... This backboard is identical to our full-sized, official conversion backboard (BA42XLC) except its 42" x 54" size makes it the most affordable glass option for side courts, recreation centers or other applications where weight or size is a serious consideration

- Play is identical except board has 9" per side less glass to hit on errant shot
- 1/2" tempered glass
- Simply remove an existing fan board and bolt up this board for a low cost conversion from steel fan to rectangular glass
- **Unconditional lifetime warranty.**



BA407G

BA407G Unbreakable Glass Side Court

A scaled down version of our popular unbreakable 42" x 72" competition glass backboard... Reduced to 42" x 54" to reduce weight and cost without sacrificing features

- Goal is mounted "off glass" so even excessive hanging will not cause stress
- **Unconditional lifetime warranty.**



BA495

BA495 Dura Steel™ Fan-Shaped

Steel, and lots of it, highlight this 39" x 54" official size backboard... Great option to replace rear mount side court backboards for greater durability

- 12 ga. skin
- Heavy-duty mounting support structure
- 5" x 5" hole pattern
- Standard 20" x 35" fan-type backboard mounting holes
- Superior front mount design
- Heaviest backboard of its type
- White powder coated finish
- Official orange shooter's square and border
- Ten-year limited warranty.



BA44XL Extended Life Competition Fan-Shaped Glass

Unbeatable warranty because this is a better built fan-shaped glass backboard... Built-in support strut greatly improves durability

- Official size 39" x 54"
- Cushioned 1/2" tempered glass
- Heavy-duty aluminum framework
- Fire-impregnated white border and shooter's square
- Industry standard 20" x 35" mounting brackets
- **Unconditional lifetime warranty.**

LED ALERT SYSTEM

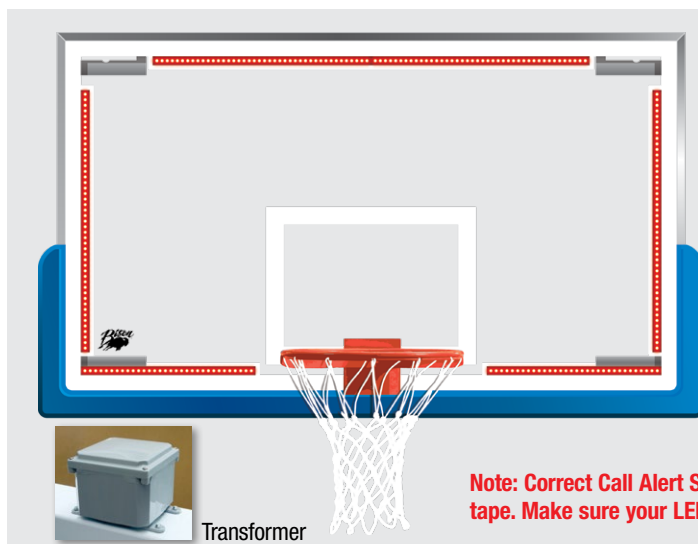

Transformer

BALED Correct Call™ LED Backboard Alert Systems

Popular at the collegiate level... LED Alert Systems are coming soon to a high school near you

- Bison's LED system is easy to install behind virtually any manufacturer's glass backboard (42" or 48" high) with no drilling and no visual hardware
- Will interface with virtually any scoreboard system that is capable of sending a signal from the official scoreboard time clock or shot clock to this 12 volt LED system
- Six separate preassembled LED light strips are mounted in aluminum tracks with high tack, self adhesive mounting tape system for quick and easy installation
- System includes LED strips for one backboard, transformer and all necessary components except the wiring that is required to run from the scoreboard signal location to the transformer box
- Call a Bison Customer Service Specialist for details
- Five-year limited warranty.

Note: Correct Call Alert Systems are not returnable once backing is removed from the adhesive tape. Make sure your LED strips are compatible with your backboard before removing adhesive.



800-247-7668



www.bisoninc.com

21



No two programs are alike and Bison offers the widest range of breakaway goal options on the market. All Bison breakaway goals are designed with durability, player safety and consistent ball rebound in mind. Most Bison breakaways meet NCAA rules regarding rebound elasticity testing. Regardless of which Bison breakaway is right for you, count on Bison to provide quality at a price that meets your needs and budget.

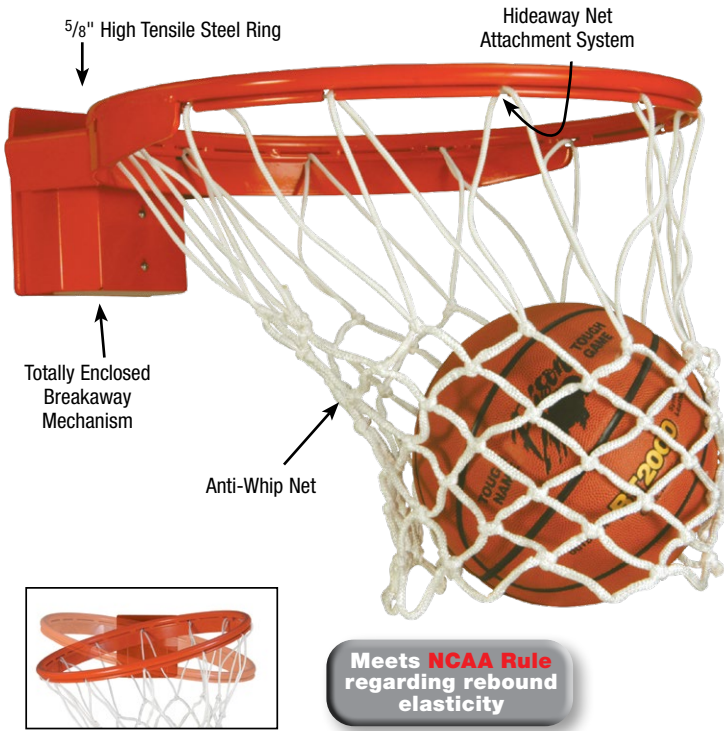

Baseline™ 180° Breakaway Goal

The **ONLY** true 180° Breakaway Goal with a Positive Lock Release Mechanism!

From the left baseline, right baseline, down the lane or any angle in between, Baseline will provide consistent breakaway pressure even during the most aggressive slam dunk action...This is the most technologically advanced breakaway goal available today with the ring assembly floating on 13 hardened chromium steel ball bearings for smooth flexibility from any direction • Pressure release mechanism is field adjustable to insure the preferred feel and adherence to NCAA ring testing rule for the life of the goal • Meets National High School Federation and NCAA standards • Includes anti-whip net and mounting hardware.

BA3180S Baseline™ Collegiate 180°

For 42" x 72" backboards...The preferred goal to use on all short 42" glass backboards at any level of play • **Four-year repair or replacement warranty.**

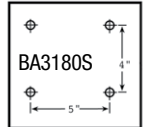

BA3180T Baseline™ Universal Prep 180°

Universal board mounting design...Same mechanism as Collegiate above but fits both 48" x 72" and 42" x 72" glass boards • Use at all levels of play • **Two-year repair or replacement warranty.**

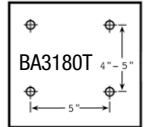

BA35E Elite Plus Breakaway

Now with Popular Hideaway Net Attachment

Bison Elite is now even better...Always one of our most popular breakaway goals for high school and college play, we now include our **super safe and durable hideaway net attachment system** previously found only on our Baseline 180° Breakaway • Other features include safety padded cover plate, AcuFlex™ adjustable tension release mechanism, 4-point lubrication system and extra heavy, fully welded 1/4" rim support and antiwhip net • Elite Plus mounts to any 42" or 48" high glass backboard with hardware included and meets all National High School Federation and NCAA standards. **Five-year limited warranty.**

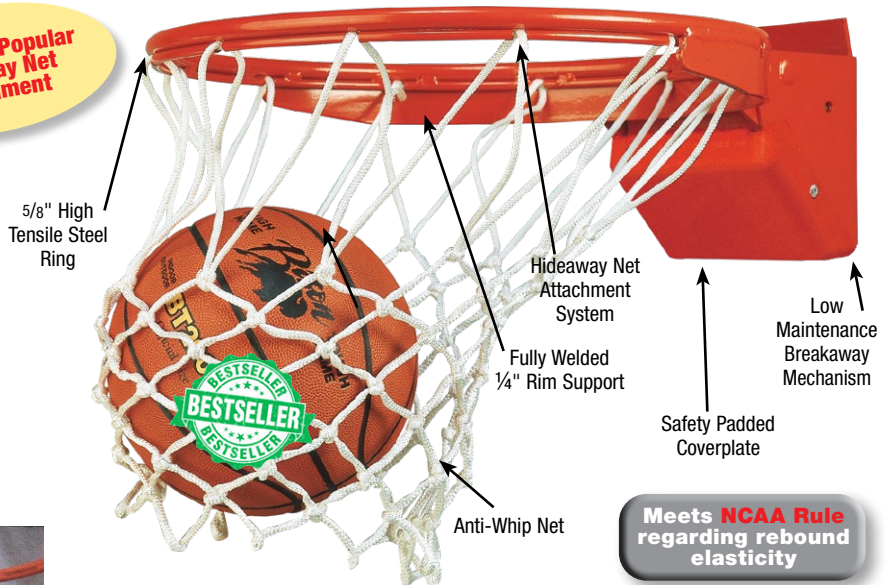

AcuFlex™ Adjustable Tension Breakaway Mechanism



Hideaway Net Attachment





**Unconditional
3-YEAR
Replacement Warranty**



Meets **NCAA Rule**
regarding rebound
elasticity

BA35 ProTech™ Breakaway

Bison's original breakaway goal is still the best value...Heat treated ball and socket, positive lock mechanism provides excellent rebound consistency over the life of the goal • ¼" rim support • Simple, maintenance-free design • Steel coverplate • Backplate fits all hole patterns on 42" and 48" rectangular and fan-shaped glass backboards • Continuous netlocks • Meets National High School Federation and NCAA standards • Includes mounting hardware and competition net • **Unconditional three-year replacement warranty.**

BA35S ProTech™ Breakaway for 42" Short Backboards

For 42" glass backboards only...Same features as BA35 above except rim mounting hole pattern is 5" x 4" only • Results in bottom of backplate being approximately 1" higher on backboard • **Unconditional three-year replacement warranty.**



**1-YEAR
Limited Warranty**

Meets **NCAA Rule**
regarding rebound
elasticity

BA34 TruFlex™ Breakaway

Economical yet durable...Meets or exceeds NCAA and National High School Federation standards • Same breakaway mechanism as Bison's BA35 ProTech goal • Steel coverplate • Backplate mounting pattern fits 42" and 48" high glass backboards • Includes competition net and mounting hardware • **One-year limited warranty.**



BA32XL Hang Tough™ Breakaway

Our most affordable competition breakaway goal...Same heavy-duty construction as ProTech but with simplified breakaway mechanism that provides consistent and long life for programs at all levels • Universal backplate • Meets National High School Federation standards • Includes competition net and mounting hardware • **90-day limited warranty.**



BA32 Heavy-Duty Side Court and Recreational Flex Goal

An affordable flex goal that can take heavy use and abuse...Simple, low-maintenance design can be used indoors or outdoors • 5/8" steel rim with 3/16" x 1½" support • 15° deflection, auto return • Universal backplate mounts to all standard boards • Durable powder coated finish • Not recommended for interscholastic high school or collegiate play • Continuous netlocks • **Order BA32S for backboards with 5" (w) x 4" (h) rim hole pattern** • Includes mounting hardware and nylon net • **One-year limited warranty.**



BA32RXT FlexCourt™ Rear Mount Flex Goal

Rear mount backboard protection with same proven mechanism as Bison's popular BA32 flex goal...Fits all brands of rear mount steel backboards • Fully enclosed mechanism • Continuous netlocks • High tensile strength 5/8" rim • Includes mounting hardware and nylon net • **One-year limited warranty.**



800-247-7668



www.bisoninc.com



BA27A

BA27A Front Mount Super Goal

Excellent upgrade from standard front mount goals at a lower cost than double rim or breakaway goals... Full 5/8" computer designed reinforcing bar gives "super support" when a player suspends from the goal • Additional 5/8" brace strengthens the vulnerable joint between rim and backplate • Continuous netlocks • 1/4" thick **universal backplate** • Packaged two goals per carton • Includes mounting hardware and nylon net • Two-year limited warranty.

BA27 (not shown)

Standard Front Mount Competition Goal

Standard 5/8" steel rim... 3/16" thick **universal backplate** for mounting to virtually all boards • 1/2" reinforcing bar, computer engineered for maximum support • Continuous netlocks • High-penetration continuous welded joints • Durable powder coated finish • Packaged two goals per carton • Includes mounting hardware and nylon net • One-year limited warranty.



BA21A

BA21A Rear Mount Super Goal

Stronger than other manufacturers' standard rear mount goals... 1/4" continuous welded support ring for over half of the rim circumference • Continuous netlocks • Heavy-duty 3/16" thick **universal backplate** mounts to all rear mount boards • Additional bracing at the backplate joint gives greater strength when player suspends from goal • Durable, baked powder coated finish • Packaged two goals per carton • Includes mounting hardware and nylon net • Two-year limited warranty.



BA51H-PK

BA51H

BA51H Anti-Whip Net

Competition grade, affordable price... Heavy braided nylon to reduce net whip common with lighter weight nets • Bright white • Use for competition or as upgrade to normal residential or playground string nets. **Note: Pink nets for non-competition indoor use only.**



BA35ARC

BA35ARC Replacement Hideaway Net Attachment Cables

Nylon coated replacement cables are compatible with Bison **BA3180S**, **BA3180T**, **BA35E** and **BA35A** Breakaway Goals • Sold in pairs.

Removable Goal Adapters



TR75 Removable Goal Package

Excellent option to add shooting stations to areas where a permanent goal would interfere with other activities... Official size goal slides easily into mounting track for quick on and off • Bracket can be mounted directly to wall or any flat surface • **Not suitable for slam dunk action** • Select wall mounting anchors (not included) based on wall construction • **Only adults should install or remove rims from bracket** • One-year limited warranty.



BA26 Economy Goal

Our most affordable goal... Affordable, yet features official size and powder coated finish • Multiple hole pattern fits many common, low cost backboards • Complete with nylon net and hardware • Use with TR74 and TR76 • Note: Will not fit 5" x 5" and 5" x 4 1/2" mounting patterns • 90-day limited warranty.

TR74 Removable Goal Bracket

Includes wall bracket only... Same bracket as TR75 • Use with BA26 goal only • **Not suitable for slam dunk action** • Customer provides wall mount anchors • **Only adults should install or remove rims from bracket** • One-year limited warranty.

TR76 Double Height Removable Goal Bracket

Allows 12" goal height adjustment... Wall bracket only • Mount goal higher for upper grades and lower for younger kids • Use with BA26 goal only • **Not suitable for slam dunk action** • Customer provides wall mount anchors • **Only adults should install or remove rims from bracket** • One-year limited warranty.



TR70RP Rim Removal Pole and Bushing

Remove the rim from TR75, TR76, TR95 or TR96 without leaving the ground... Just screw pole into threaded bushing in rim and lift for safe and easy rim removal to avoid unwanted use, vandalism or theft • **For use by adults only.**



Easy-Up™ Youth Mini Goals

Over 40,000 Easy-Up™ Mini Goals are in service in youth camps, YMCAs, YWCAs, elementary schools, church recreation centers, basketball camps and city recreation facilities.

For over 30 years, Easy-Up has put the rim within reach and helped to teach aspiring young basketball players proper shooting techniques... Equipment with official 10' goal height can be converted in less than five minutes with no use of tools • Only Easy-Up will fit on virtually any style of single-ring goal, breakaway or non-breakaway, regardless of manufacturer, age or condition • An Easy-Up goal lowers rim and moves rim 24" closer to free throw line • The full size rim allows play with either full sized or reduced size balls depending upon player age • Standing as low as 2' above the floor, one person can easily attach the tubular frame to a 10' goal with a unique cam operated lever • Total system weight is less than 40# • 48" x 32" backboard is molded of high impact ABS plastic • Ships completely assembled • Not suitable for dunking or hanging from goal • One-year limited warranty on structure and goal, **lifetime limited warranty on backboard.**

TR86 6-in-1 Adjustable Easy-Up™

Age appropriate goal height for kids of all ages now available in a single adjustable unit...This one model can be set at 6½', 7', 7½', 8', 8½' or 9' goal height for kids as young as four years old • Two minute height adjustment without tools.



Now with **SIX** HEIGHT SETTINGS

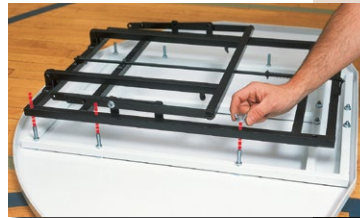

6-in-1 Adjustment is Quick and Easy

TR86 6-in-1 Adjustable 6½' to 9' Goal for Any Age

See [YouTube.com/bisoninc](https://www.youtube.com/bisoninc) for Product Videos 



Less Than 40# Lifting Weight



For Transport or Storage Folds with three thumb screws to 48" x 32" x 7" and has built-in carrying handle.



7½' Goal Height for Ages 3-5



8' Goal Height for Ages 5-7



8½' Goal Height for Ages 8-10

WARNING!
Easy-Up Youth Mini Goals are not for residential or outdoor institutional use. Adult installation is required. Use in supervised play only. **ABSOLUTELY NO HANGING OR DUNKING.**



800-247-7668



www.bisoninc.com



Heavy-Duty Ball Carts **These May Be the Last Ball Carts You'll Ever Buy**

Possibly the last ball cart you'll ever need to buy...Designed and tested to support up to 250#, these carts might last forever • Constructed of welded 1" square heavy wall tubing with 3/4" steel chrome plated, horizontal ball supports • Choose from standard or lockable model with ball capacities to match your program's needs • Carts are available in six popular colors and can be customized with optional ABC92 lettering • Fits men's or women's basketballs • Floor-friendly casters • Some assembly required • **Five-year limited warranty.**



5-YEAR Limited Warranty

BA185-SC with Optional ABC92 Lettering

BA125-RY with Optional ABC92 Lettering



5-YEAR Limited Warranty

BA165-SV with Optional ABC92 Lettering



Lockable Ball Carts Locking End
Carts now have capacity for 16 or 24 balls...Lock to protect your basketball investment • Customer provides padlock • 23" width for easy storage • Six color options shown below • Optional ABC92 lettering can be applied on one end (two lines) • **Five-year limited warranty.**

BA165 Ball Cart
16 ball capacity.

BA245 Ball Cart
24 ball capacity.



Ball Carts

Choose a cart for 12 or 18 balls...Choice of six colors shown below • Optional ABC92 lettering can be applied on both ends • The best ball carts you'll ever own • **Five-year limited warranty.**

BA125 Ball Cart
Holds 12 balls.

BA185 Ball Cart
Holds 18 balls.



5-YEAR Limited Warranty

BA187 SharpShooter™ Ball Cart

Built for rapid fire shooting practice... Durable ball cart holds a total of 19 women's or men's basketballs including 7 on the top row that gravity feed to one end for maximum shots per minute

- Choice of six colors shown below
- **Five-year limited warranty.**

BA175 25 Ball Security Locker

Secure your investment in inflatables... Sturdy black coated wire and tubular locker • Hinged, lockable top (lock not included)

- Overall dimensions 26" (w) x 46" (l) x 43" (h)
- Easy to roll with convenient handle and heavy-duty swivel casters
- Holds approximately 25 basketballs, volleyballs, footballs, soccer or miscellaneous game balls and equipment
- One-year limited warranty.



BA175

ABC92 Custom Lettering

Custom lettering for your school name or nickname...up to 10 letters per side or line • See page 95 of catalog for available lettering colors and styles • Customer applies lettering at assembly.

Powder coat color options for BA125, BA165, BA185, BA187 and BA245 Ball Carts.





Maximize school, team or program spirit by including Bison Sport Pride™ equipment in your plans when you redecorate, renovate or build your facility. Bison's design team will work with you using your existing logos or artwork, work from your rough concept or show you a variety of awesome stock standard team logos.

Choose from a wide variety of Bison sport and event related equipment, all designed taking advantage of our full color printing resulting in color photo quality images.



Design



Print



Assemble



Graphic Wall Padding



Goalpost Padding



Scorers Table



Team Chairs



Scorers Tables in Bleachers



Graphic Outdoor Padding



Lettering and Logos



Graphic Wall Padding

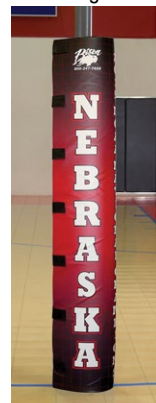

Volleyball Padding



Graphic Wall Padding

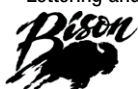



Now Upgraded
to LED for Longer Life
& Energy Savings



FREE!
SC500 Possession Arrow
on 8' Scoring Table

ST85FI Sport Pride™ Illuminated Scorers Tables

ST85FI 8' Table

Let the light shine through with Bison Sport Pride Illuminated Scoring Tables...Tables have profile identical to Bison's full color graphic models so tables can be configured in any length and in any combination of styles to meet your facility's needs and budget • Support legs and 16" deep table top fold for easy transport and storage on built-in, non-marking casters • Front graphics are printed on a durable, translucent substrate and protected by unbreakable clear polycarbonate for a lifetime of sharp, bright images • Can be used either on the floor with chairs or mounted on a customer fabricated platform a few rows up in most bleachers • Ends are fully padded and can be lettered with school name • Top edge has matching safety padding • Each table includes a 120 volt power strip with surge protector • See Convertible drawing on the following page for profile information • Requires 20 amp, 120 volt service • Illumination is provided by three LED tubes (included) • Five-year limited warranty on tables except lamps.



Compact For Easy Transport
and Storage

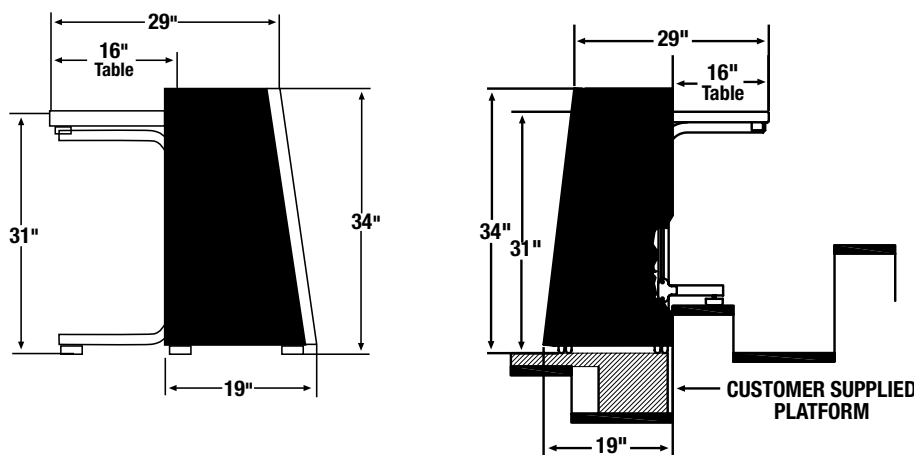

Convertible Table on Floor

Convertible Table in Bleachers

Style	8' Convertible
Approx. Graphic Size	31" x 96" (20 sq. ft.)
Actual Overall Dimensions	34" (w) x 34" (h) x 102" (l)
Power Requirement	120 Volt AC, 20 AMP
Table Depth and Height	16" (d) x 31" (h)
Stored Dimensions	20" (w) x 34" (h) x 102" (l)
Possession Arrow Included	Yes

Special liftgate delivery charge or
extreme manual lifting required if
dock/forklift not available.





ST85F 8' Convertible Table on Floor

FREE!
SC500 Possession Arrow



ST85F in Bleachers

Sport Pride™ Full Color Graphic Scorers Tables

The perfect blend of safety, function and school pride...Realistic color graphics, same as found on our popular Sport Pride wall padding, cover the entire front and sides of these scorers tables • Available in 12' or 8' models • Any number of 12' and 8' tables can be placed side-by-side with graphics coordinated to create any length of continuous scorers table capacity • Tables fold easily for transport and storage • Choose from Convertible or Space Saver models • See selection chart and profile information on following page • Includes full color printed graphics on front panel and mascot or school name on each side pad • Super narrow storage width • Full color printing process allows infinite color selection • Folding 16" deep table with drink holders • Padded front and sides have 14 oz. anti-mildew, UV protected and fire-retardant vinyl over 2" thick urethane foam • Built-in, floor-friendly transport casters • 110 volt receptacles for computer, shot clock, etc. • One-year limited warranty.

ST85F/ST125F Convertible Scorers Table (Freestanding on Floor)

The most common use of our convertible 8' (ST85F) or 12' (ST125F) scoring tables is setup on the floor with chairs providing the seating • Purchase Bison **STC500S** chairs to provide seating coordinated with your scoring table.

ST85F Convertible Scorers Table (Installed in Bleachers)

When space between the court and the bleachers is limited, Bison convertible scoring tables can be used at any height in the bleachers using a wooden field constructed platform • This allows scoring and statistical personnel to sit on existing bleacher seats • Bison will provide a universal design platform drawing on request.

ST85B Space Saver Scorers Table (Up Against Bleachers)

This extra tall table allows the table to be positioned on the gym floor, up against the first row of bleacher seats • The height is designed to allow personnel to sit comfortably on the second row of bleacher seats • Space Saver is the best choice if the gym does not want to put scoring tables in the bleachers but has limited floor space outside the sidelines • Normally requires at least 48" of space between front of bleachers and court sidelines.

"The Bison scorers table we purchased was more than we bargained for! The graphics were outstanding, the quality was excellent and the price was reasonable. I was impressed with the turnaround time and how well it was constructed. It has had a positive impact on our school spirit. Anyone who walks into the gym notices the table right away. When people ask who we got it from, I direct them to Bison with positive recommendations."

Rob Murphy
St. Ignatius High School,
Thunder Bay, Ontario



ST85B Space Saver Table



800-247-7668



www.bisoninc.com



ST84F Shown with Optional SC500 Possession Arrow

ST84F 8' School Spirit™ Activity Table

Step up to the big leagues... But at a little league price • Great for use as a basketball or volleyball scorers table but equally at home at speech and debate, wrestling matches, bake sales or anywhere school spirit is alive and well • Front and side panels are fully padded for player protection • Printing of full color graphics on the front panel and mascot or school name on side panels is included in price of ST84F • Easy to store, all panels attach with hook and loop fasteners • Padded front panel is approximately 30" x 96" • 2" thick front and 1" thick side padding • Seats four comfortably • 5 minute set up and tear down • Stores in area 8' x 3' x 1' • Full 30" x 96" table top • One-year limited warranty.



Easy Transport and Storage



Hook and Loop Front and Side Panel Attachment



"Mt. Olive is a small school and it was nice to have someone pay attention to every detail to make our scorers table the very best. Our Sports Boosters donated the money to purchase a Bison Sport Pride scorers table and they wanted our table to mirror the Wildcat painting in our gym. The customer service I received was second to none and the artwork is amazing!"

Drew Logan, High School Basketball Coach
Mt. Olive High School, Mt. Olive, IL



SC500 Slimline Possession Arrow

Space saving thin design... Leaves more room for scorekeeper duties • Bright red illuminated electronic arrows • 120 volt, 15' power cord 6" (h) x 20" (w) x 2" (d) enclosure • One-year limited warranty.



Team Chairs Upgraded
for Superior Comfort
and Durability



STC500S Sport Pride™ Team Chairs

Upgraded for superior durability... Now with .75" x 1.63" rectangular legs and support structures but with the same comfortable 3" thick padded, 18" wide seat • Compare with other manufacturers' seats with lighter weight steel legs, thinner padding or inferior construction • Available in a wide variety of frame and vinyl cover colors and a nearly infinite array of 1 or 2-color silk screened logo and lettering options • Minimum order 12 chairs for printed options, 4 chairs for solid color • Work with Bison custom art specialist to select frame and vinyl color and to design great custom lettering and logo designs • Choose from Black, Maroon, Scarlet, Orange, Kelly, Forest, Royal, Navy, Purple and White frames • Choose from Black, White, Scarlet, Maroon, Orange, Purple, Royal, Navy or Forest vinyl seat covers • **STCART** artwork charge required • See **STC036** for transport cart • Order one **STC500CONN** per chair to connect chairs in a row • Now with three-year limited warranty.



STC300S Sport Pride™ Team Stools

Instant seating wherever you want it... Locker rooms, game timeouts or any time • Tubular steel frame • 20" comfortable seat height • Must be ordered in multiples of four • Minimum order 12 for printed options, 4 for solid color • Bison's Art Department will assist in design • Choose from Black, Maroon, Scarlet, Orange, Kelly, Forest, Royal, Navy, Purple and White frames • Choose from Black, White, Scarlet, Maroon, Orange, Purple, Royal, Navy or Forest vinyl seat covers • **STCART** artwork charge required • One-year limited warranty.



STC036 Sport Pride™ Chair Transport Cart

Stores up to 36 Team Chairs...

Transports, too • Floor friendly casters • Solid steel frame

- Loaded dimensions 31" (w) x 60" (l) x 75" (h)
- One-year limited warranty.



STC100 Sport Pride™ Chair Back Covers

Customize standard folding chairs...

Show your program's spirit

- Full color graphic printing for logos and lettering • Durable sewn vinyl construction • Fits Bison Team and most standard folding chairs • Bison's Art Department will assist in design
- Minimum order of four chair covers
- **STCART** artwork charge required.





If you need safety padding...we've got you covered. Bison has the perfect team to design and construct padding to protect players from virtually any surface from simple flat walls to columns, doorways and overhead obstructions. With a wide variety of foams, fabrics, backing substrates and mounting methods, we will help you provide the padding system that best satisfies your program's needs. Let our graphic design staff work with you to make your padding system not only offer superior safety but also exhibit your program pride with full color, durable graphic designs.



Full Color Graphic Wall Padding

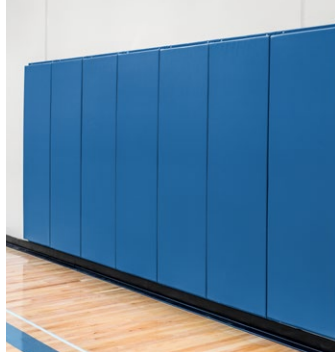

Solid Color Wall Padding



Custom Factory Cutouts



Molded Outlet Openings (Single or Duplex)



Flange Mounting System



Hidden Z Track Mounting System



Wood Backed Hook and Loop Fastener Track Mounting System



Soft Back Hook and Loop Fastener Track Mounting System



J Track Mounting System



Custom Entry Padding



Square Column Padding

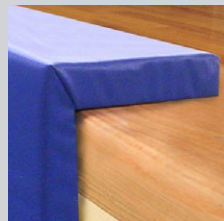

Stage Padding



Corner Padding

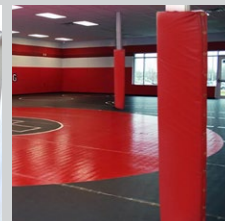

Hook and Loop or Laced Pole Wraps



Beam Padding

Specialty Wood Backed Padding Applications

Protect players from injury...columns, beams, entry ways, corners, stages and other protruding surfaces need special padding systems

- Bison can provide custom designed padding for virtually any application
- Work with our padding design staff to pad your most challenging surface
- Available to meet either Protector™ 2" polyurethane or Firewall™ 2" neoprene specifications (see page 35).

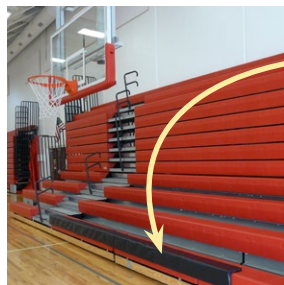

WP466-BK Removable Bleacher/Stage Padding
Need low cost protective padding for bleachers, stages or other vulnerable corners?...L-shaped padding has 7" wide legs with heavy black vinyl cover sewn over dense 1" thick foam • May be attached with the hook and loop fasteners provided

- Sold in sets of four 4' long sections so each WP466-BK will protect 16' of corner protrusions.

Custom Soft Backed Pole Wraps

Wrap around design can use lace or hook and loop closure...available in 1" or 2" thick Protector™ polyurethane foam or Firewall™ neoprene foam • Can be sized to fit virtually any size posts • Bison padding design department will help you determine the right design and specification for your facility.

Custom Sewn Soft Backed Padding

Virtually any size, virtually any flat design...Soft backed sewn padding can be designed in a wide variety of foam thickness and specifications • 18 color options (see page 95) and multiple hanging and mounting methods • Contact our padding design specialists to design soft backed sewn padding to fit your needs.





Sport Pride™ Graphic Wall and Stage Padding

There is no limit to the design options available to enhance your gym's sex appeal...options are limited only by you and our art department's imaginations • Our digital printing process can provide photo quality, full color graphics and bright letters and logos in a near infinite range of colors

- Recognize a significant program donor, honor past championship teams, communicate an important program theme or just make your wall padding pop
- Durable images that will look good for years • Sport Pride graphic padding can be provided in any size or configuration built to our standard Protector™ specifications, our Firewall™ specifications (see page 35) or any of our wall padding upgrade options below.



800-247-7668



www.bisoninc.com



Solid Color Wall Padding

While full color graphic wall padding continues to grow in popularity, solid color padding is still the most common option, especially when padding large sections of walls or where tight budgets demand. Solid color padding also has the advantage of being able to more easily cover beams, doors, corners, and surfaces that would be impractical to design full color graphic padding for.

It is also possible to mix and match solid color padding with graphic padding, to take advantage of the relatively low cost of solid color padding, but add that extra something special to certain high visibility areas.

Like graphic padding, solid color padding is available in a wide range of colors shown on the following page, and can be ordered to meet any architectural or code specifications for fire resistance, thickness, foam density, or mounting preference.

See following pages for options.

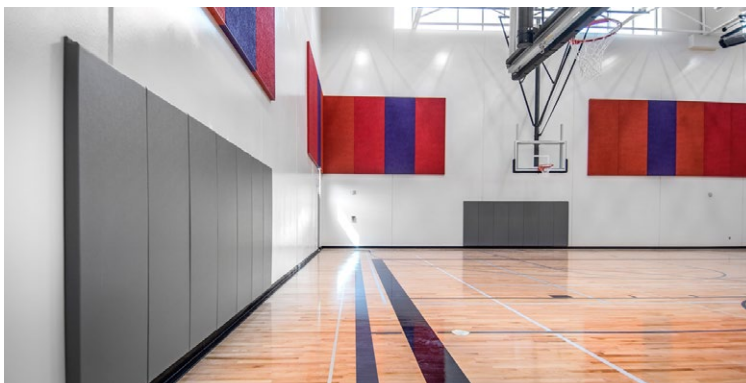

Wall Padding Solid Color Vinyl Options

DR-Dark Royal

RY-Royal

SC-Scarlet

BK-Black

NY-Navy

PK-Pink

FG-Forest Green

GL-Athletic Gold

PR-Purple

MR-Maroon

OR-Orange

KL-Kelly Green

CL-Columbia Blue

GR-Gray

BR-Brown

BO-Burnt Orange

CD-Cardinal

VG-Vegas Gold

NOTE: ALL COLORS ARE NOT AVAILABLE ON FIREWALL PADDING



Protector™ Wall Padding Specifications (Standard Specs)

All full color graphic and solid color Protector wall padding including custom corner, column, door and stage padding is constructed of polyurethane foam with an Indentation Load Deflection (ILD) of 43-53 pounds per 50 cubic inches and 1.50 pounds per cubic foot density per ASTM Tests B1 and A

- Foam conforms to California Fire Code TIB 117:2013 Section 3 and FMVSS 302
- Foam also conforms to ISO 20743:2007 Antibacterial and AATCC 30 Antifungal Standards
- 14 ounce vinyl covering has a ASTM D2261 tear strength of 92 x 83 pounds per inch and has been treated for mildew and UV protection
- Vinyl conforms to NFPA-701 CSFM and has a Class A fire rating per ASTM E-84
- Wood backed padding is mounted on 7/16" OSB composite board with the foam attached to the OSB with water based adhesive.

Firewall™ Wall Padding Specifications (Standard Specs)

Full color graphic and solid color Firewall padding including custom corner, column, door and stage padding is constructed of neoprene foam with Indentation Load Deflection (ILD) of 25-45 pounds per ASTM D3574 Test B1 and a density of 6.2 pounds per cubic foot per ASTM D3574 Test A

- Firewall Neoprene foam passes California Fire Code TIB 117:2013
- 16 ounce leather grain vinyl has a toungue tear strength of 75 x 75 pounds per inch, has been treated with anti-mildew and UV protection, conforms to NFPA-701, CSFM and has a Class A fire rating per ASTM E-84
- Wood backed padding is mounted on 7/16" OSB composite board with the foam attached to the OSB with water based adhesive
- Assembled padding has been tested and passes NFPA 286 fire testing and passes ASTM E-84 Class A fire rating for wall coverings
- Firewall is available in graphic and in limited solid color vinyl colors
- Call for details.

These colors do not accurately represent actual solid color vinyl. Request a vinyl sample for color match if needed.



PARTNER



800-247-7668



www.bisoninc.com

35

INDOOR WALL PADDING ORDERING CHART

Bison offers a wide range of wall padding options to match every facility's needs, and meet every local and state code. Choose from our basic Protector™ 2" thick polyurethane foam, or our Firewall™ 2" neoprene, with or without wood backing. Bison offers 4 wall mounting options, and any padding can be upgraded to meet more stringent specifications and codes with the options outlined below.

In most cases, all wall padding is priced by the square foot, but the most common size is 2' wide and 6' high. See chart below for all standard, and upgrade options. Solid vinyl colors are shown on page 35.



Custom Wall Padding Options					
Model Number	Style	Foam	Backing	Vinyl Cover	Mounting System
WP2USFW	Protector™	2" Polyurethane	7/16" OSB	14 oz. Solid Color	Flange
WP2USZW	Protector™	2" Polyurethane	7/16" OSB	14 oz. Solid Color	Z-Track
WP2USJW	Protector™	2" Polyurethane	7/16" OSB	14 oz. Solid Color	J-Track
WP2USVW	Protector™	2" Polyurethane	7/16" OSB	14 oz. Solid Color	Hook & Loop
WP2USVS	Protector™	2" Polyurethane	Soft Back	14 oz. Solid Color	Hook & Loop
WP2UGFW	Protector™	2" Polyurethane	7/16" OSB	14 oz. Graphic	Flange
WP2UGZW	Protector™	2" Polyurethane	7/16" OSB	14 oz. Graphic	Z-Track
WP2UGJW	Protector™	2" Polyurethane	7/16" OSB	14 oz. Graphic	J-Track
WP2UGVW	Protector™	2" Polyurethane	7/16" OSB	14 oz. Graphic	Hook & Loop
WP2UGVS	Protector™	2" Polyurethane	Soft Back	14 oz. Graphic	Hook & Loop
WP2NSFW	Firewall	2" Neoprene	7/16" OSB	16 oz. Solid Color	Flange
WP2NSZW	Firewall	2" Neoprene	7/16" OSB	16 oz. Solid Color	Z-Track
WP2NSJW	Firewall	2" Neoprene	7/16" OSB	16 oz. Solid Color	J-Track
WP2NSVW	Firewall	2" Neoprene	7/16" OSB	16 oz. Solid Color	Hook & Loop
WP2NSVS	Firewall	2" Neoprene	Soft Back	16 oz. Solid Color	Hook & Loop
WP2NGFW	Firewall	2" Neoprene	7/16" OSB	16 oz. Graphic	Flange
WP2NGZW	Firewall	2" Neoprene	7/16" OSB	16 oz. Graphic	Z-Track
WP2NGJW	Firewall	2" Neoprene	7/16" OSB	16 oz. Graphic	J-Track
WP2NGVW	Firewall	2" Neoprene	7/16" OSB	16 oz. Graphic	Hook & Loop
WP2NGVS	Firewall	2" Neoprene	Soft Back	16 oz. Graphic	Hook & Loop



EASY TO ORDER!

2' wide x 6' high Standard Wall Padding Options					
Model Number	Style	Foam	Backing	Vinyl Cover	Mounting System
WP62UF	Protector™	2" Polyurethane	7/16" OSB	14 oz. Solid Color	Flange
WP62UZ	Protector™	2" Polyurethane	7/16" OSB	14 oz. Solid Color	Z-Track
WP62NF	Firewall	2" Neoprene	7/16" OSB	16 oz. Solid Color	Flange
WP62NZ	Firewall	2" Neoprene	7/16" OSB	16 oz. Solid Color	Z-Track

PADDING UPGRADE OPTIONS



WPUP3U

Upgrade any 2" polyurethane foam wall padding to 3" polyurethane foam for added player protection or to meet local codes or project specifications.

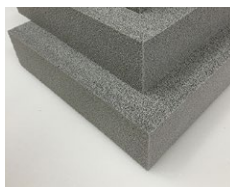

WPUP3N

Upgrade any 2" neoprene foam wall padding to 3" neoprene foam for added player protection or to meet local codes or project specifications.



WPUPFR

Upgrade any wood backed wall padding to add a fire retardant coating to the 7/16" OSB backing to meet local codes or project specifications.



WPUP2HD

Upgrade any 2" polyurethane foam wall padding to 2" high density foam for added player protection or to meet local codes or project specifications.



WPZ3 Third Row Z-Track

Occasionally specifications call for 3 rows of Z channel mounting tracks due to padding height or other conditions. Call for details on how to add the 3rd row to your padding needs.



All Weather™ Outdoor Padding

Neither snow nor rain nor dark of night...Oh wait, that's the US Postal Service motto, but it also applies to our All Weather Outdoor Padding and you can add heat, humidity, hail, sleet, wind, sunlight, frost and virtually any other common weather term to describe our padding's durability • Typical All Weather Padding features ¾" BC SYP exterior grade plywood, 100% rust-proof stainless steel, brass or aluminum hardware and fittings, 3" thick mildew-resistant polyurethane foam and heavy outdoor durable vinyl coverings • Choose from sunfast solid color or full color graphic options • Each assembled panel, regardless of size, is vented at the bottom to allow moisture to escape, increasing both functional and aesthetic longevity • Outdoor padding is available in many sizes, styles, custom configuration and in colors shown on page 95. All Weather padding comes standard with flange style mounting but consult our Bison Padding Specialists to determine if "Z" Track Mounting, Chain Link or Hook and Loop Mounting better fits your specific needs for part or all of your installation.

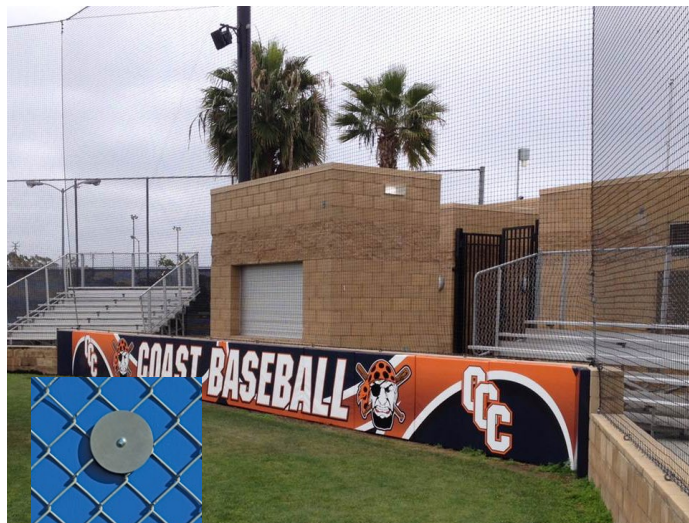

Chain Link Fence Mounting Option

Outdoor Padding Specifications

Unless otherwise indicated, all outdoor Full-Color Graphic, Two-Color Lettered, and Solid Color vinyl outdoor padding is constructed of ¾" FDN CCA treated southern yellow pine plywood with adhesive applied 3" anti-microbial polyurethane foam. All outdoor padding is covered with fabric backed, flame retardant, mildew and UV resistant 16 oz. leather grained vinyl. All vinyl is tightly stretched around the foam and stapled to the plywood with rust-proof stainless steel staples no less than 2" apart. Mounting styles will vary depending upon specific requirements. Specifications may vary on custom sizes, shapes, and configurations to meet site-specific requirements.



Hook and Loop

Tubular Hook and Loop Rail/Pole Wraps

Neat, Easy, Safe, Durable...describes the 1" thick semi rigid urethane foam wraps • 14 oz. sewn vinyl cover with full length heavy-duty hook and loop fastening to use indoors or outdoors • Available in 17 colors (see page 95) • Priced by the lineal foot • Standard length 6' (custom lengths available). See chart below for sizes.

Model #	Inside Diameter	Foam Thickness	Fits Schedule 40 Pipe Size
WPRAIL200	2"	1"	1½"
WPRAIL238	2⅞"	1"	2"
WPRAIL350	3½"	1"	3"
WPRAIL450	4½"	1"	4"



WPRAIL Fence Rail and Dugout Padding

Easy to order, easy to install...8" wide x 1" thick polyurethane foam is covered in 14 oz. vinyl in your choice of 17 popular colors • Standard length is 6' but can be made in shorter lengths as desired • Designed to wrap around typical chain link style fence with top rail up to 2½" diameter and attached with WPRAILCT cable ties (order separately) • Will flex around corners if needed • Brass attachment grommets are spaced 6" apart for secure attachment • Padding is 100% sewn construction with high tensile outdoor thread • Priced by the lineal foot.



800-247-7668



www.bisoninc.com



With 13 options to choose from if Bison doesn't offer the perfect option for your facility, it probably doesn't exist. Consider these factors before you buy.

Net Height Adjustment Ease Fine tuning of the net height to meet volleyball rules can be time consuming and irritating especially for inexperienced net system setup staff. Some manufacturers including Bison offer net systems that allow small net height adjustments with an integrated hand operated adjustment lead screw with only minor or no reduction in net tension. See Bison VB1100 and VB7000 for Bison options.

Winch Durability The winch is the "heart" of a volleyball system and is critical to providing proper net tensioning, smooth operation, and long-term durability. Bison has always offered a lifetime warranty on the winches we include with all 3" diameter carbon fiber, aluminum, and steel posts and we recently made additional design and assembly improvements to this winch to further reduce the risk of failure in the field. We have also expanded our in-house testing to insure that every winch that leaves our facility will match the quality that our customers deserve. Is there any reason to buy a volleyball system that doesn't have a lifetime post and winch warranty?

Floor Attachment Most programs want the convenience of posts that drop into floor sockets permanently mounted in the floor. Some gymnasiums, such as upper level gyms, facilities with portable floors or ice refrigerant lines in the sub floor, however, are difficult if not impossible to fit with floor sockets. In these cases, portables that only require floor anchors might be preferable. Truly portable systems (no floor anchoring) are available and generally have a higher price tag and/or require significantly more storage area.

Post Weight Starting in the 1990's, lightweight aluminum posts gained popularity due to their relative ease of set up and storage. Some buyers have, however, become disenchanted with their aluminum systems due to lack of durability and rigidity. The value of lightweight posts will depend upon how often you set up and tear down your equipment and, in the case of many manufacturers, your tolerance for excess post deflection when the net is tensioned. Some aluminum systems outperform those from other manufacturers. The newest technology available uses carbon fiber to achieve **lighter than aluminum, as stiff as steel results.**

Deflection For ideal playability, the top rope of a competition net is usually tensioned between 150# and 250#, depending on the system. This tension causes some inward deflection of even the most rigid steel posts. Excessive deflection makes net tensioning and net height adjustment difficult and results in unsightly bent posts. Choose a system that you feel balances weight, features and deflection. Steel and carbon fiber posts are most rigid. Aluminum posts are less rigid and deflection varies greatly from manufacturer to manufacturer.

Program Level Your needs will vary depending upon the intended level of play. Systems with telescoping net height adjustment, where the top of the net is always level with the top of the posts, are most popular with collegiate and elite high school programs. Other systems that offer features like tennis to volleyball height adjustment are common for programs that want to use the

same systems for competition power volleyball one day and recreation and physical education classes the next. Generally these systems offer not only versatility but also tight budget affordability.

Post Size If you are installing a new system including floor sockets, the size of the selected posts will automatically match your new sockets. Retrofitting new systems into existing sockets, however, requires purchasing posts to match your sockets. There are three competition sizes in the industry: 3", 3½" and 4" (100mm). Most manufacturers offer adapters which allow you to put smaller posts into bigger sockets. Some are free (including Bison's), others are at an additional cost. Installation of large posts in small sockets is possible but not ideal. Check with the manufacturer before you buy. Totally replacing existing sockets is an undesirable and expensive option in most cases. See page 47 for options.

Transport and Storage In a perfect world, you would snap your fingers and your volleyball system would magically appear. While it's not a perfect world, your equipment selection will, in large part, determine your future set up time and efforts. If you are selecting from the wide range of other transportable pole systems, consider issues such as pole weight, available storage and transport dollies to make the best decision for your program.

Budget There is a wide range of systems that meet all applicable NCAA, National High School Federation and USVBA rules. Like any equipment, the amount you wish to spend depends upon your budget and the features your program needs. Generally, you pay more for the convenience of lightweight aluminum. New high tech carbon fiber systems are priced above aluminum but have many additional features including superior resistance to deflection.

Post Padding Most programs want padding to match their school or facility colors. Some manufacturers offer limited colors or charge extra for expanded color options. Adding lettering to the padding is now very popular as it helps increase school spirit and improves the look of your courts. By and large, stick-on vinyl letters are not a good long-term lettering option as they will curl over time. **Most complete Bison systems ordered offer printed lettering or, in some cases, full color graphic padding at no extra charge. Bison also offers optional full color graphic padding as an upgrade option.**

Warranty You'll want to know that the manufacturer will stand behind the product in the event of needed repairs or part replacement. Look for written warranties and buy from manufacturers who have a strong reputation for dependable customer service. **Purchasing through a local dealer is not only friendly to the local economy but improves your service when you need help.**

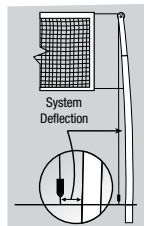

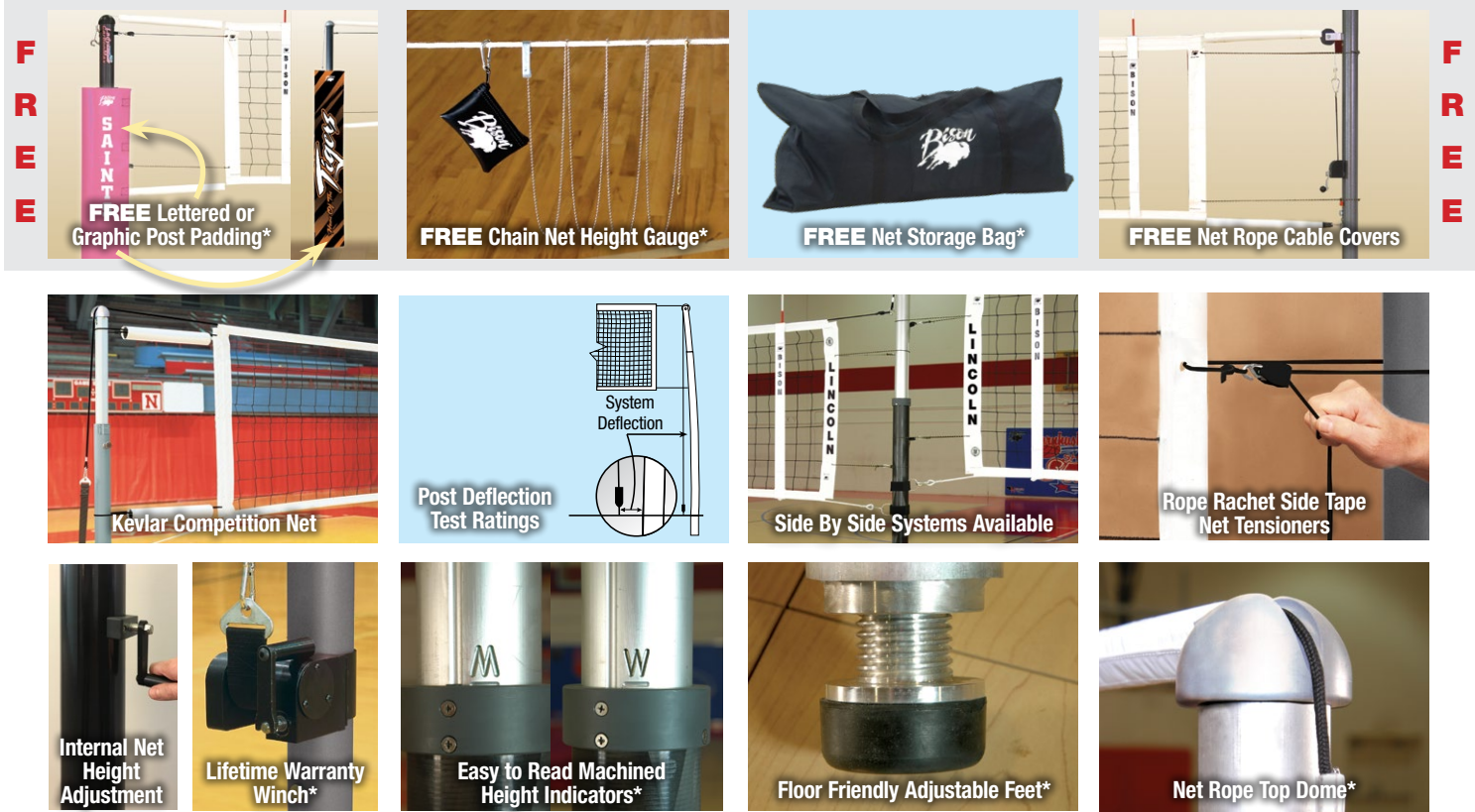

*on most systems

COMPARE FEATURES BEFORE YOU BUY YOUR NEXT SYSTEM

	CarbonLite VB7222	CarbonMax VB7000	Lady CarbonMax VB3000	Centerline Aluminum VB1000	Centerline Aluminum EZ VB1100	Centerline Steel Hybrid VB2000	Match Point Aluminum VB6000	Arena II Portable VB8100	Arena JR Portable VB8100JR	QwikCourt Portable VB8200	QwikCourt Portable VB8250
Post Material	Carbon Fiber	Carbon Fiber	Carbon Fiber	Aluminum	Aluminum	Steel/Aluminum	Aluminum	Steel	Steel	Aluminum	Aluminum
Post Diameter	3"	3½" above floor	3½" above floor	3"	3"	3"	3½"	3"	3"	3"	3½"
Post Weight w/o Winch	16#	32#	19#	34#	39#	61#	39#	N/A	N/A	N/A	N/A
Post Weight w/Winch	21#	37#	24#	39#	44#	66#	43#	N/A	N/A	N/A	N/A
Net Height Range (Approx.)	72" to 98"	78" to 98"	87" to 89"	72" to 98"	72" to 96"	72" to 98"	42" to 96"	80" to 98"	84" to 98"	72" to 98"	72" to 98"
Net Height Adjustment	Telescoping	Internal Lead Screw	Foot Pad Only	Spring Assisted Telescoping	Internal Lead Screw	Spring Assisted Telescoping	Slider Bar	Spring Assisted Telescoping	Spring Assisted Telescoping	Spring Assisted Telescoping	Sliding Track
Approx. Deflection*	1.50"	.98"	1.25"	1.97"	1.35"	1.25"	2.81"	.50"	1.25"	2.00"	2.00"
Side-by-Side Option Available	Yes	Yes	Yes	Yes	Yes	Yes	Yes	Yes	Yes	No	No
Winch Warranty	Lifetime Limited	Lifetime Limited	Lifetime Limited	Lifetime Limited	Lifetime Limited	Lifetime Limited	10-Year Limited	Lifetime Limited	Lifetime Limited	Lifetime Limited	10-Year Limited
Relative Cost	\$\$\$\$\$	\$\$\$\$\$	\$\$\$\$	\$\$\$	\$\$\$	\$\$\$	\$\$	\$\$\$\$\$\$\$\$\$	\$\$\$\$\$\$\$\$\$	\$\$\$\$\$\$	\$\$\$\$

*Compare to some popular aluminum systems with 3"+ of deflection.



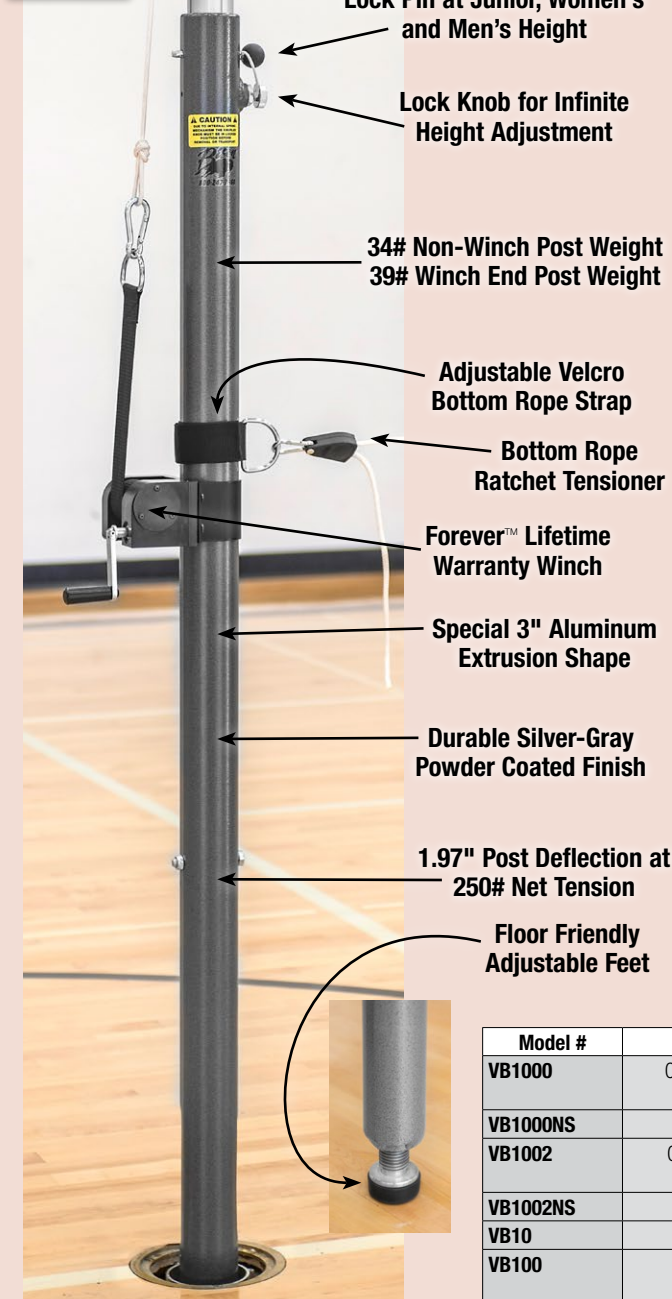
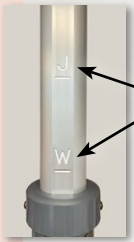

Bison Exclusive Top Rope Dome

Special 2½" Aluminum Extrusion Shape



Spring Assisted Telescoping Net Height Adjustment

Permanently Engraved Net Height Indicators

Lock Pin at Junior, Women's and Men's Height

Lock Knob for Infinite Height Adjustment

34# Non-Winch Post Weight
39# Winch End Post Weight

Adjustable Velcro Bottom Rope Strap

Bottom Rope Ratchet Tensioner

Forever™ Lifetime Warranty Winch

Special 3" Aluminum Extrusion Shape

Durable Silver-Gray Powder Coated Finish

1.97" Post Deflection at 250# Net Tension

Floor Friendly Adjustable Feet



VB1000 Centerline® Elite Aluminum

Division I college and elite high school programs that desire the perfect balance between weight, cost and post deflection have made this a top seller. The most rigid aluminum system on the market, this 34# telescoping post fits any 3" floor sockets.

Additional Popular Features on Complete Systems:

- Kevlar Competition Net
- VB13 Antennas and Boundary Tapes
- Rope Ratchet Side Tape Tensioners
- Available as Side-by-Side Court Option
- Free 1 Color Lettered Post Padding
- Free Net Storage Bag
- Free Net Rope Cable Covers
- Free Chain Net Height Gauge
- Free Socket Adapters (on request)
- Substitute VB10C and VB100C Posts for use in Existing 1 7/8" Floor Sockets
- Order VB51PGUP to Upgrade to Graphic Post Padding

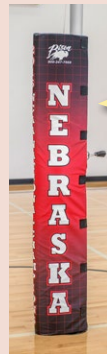
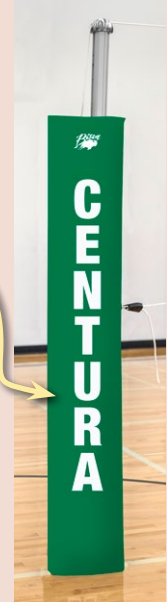

"Steel is great in cars or buildings, but when the University of Arizona volleyball team practices in the Wildcats basketball arena, we got tired of hauling the heavy systems in and out. I'd never considered aluminum systems because of negative comments from other coaches. I am now a firm believer that weight alone is not the measure of a quality volleyball system. While Centerline Elite aluminum standards won't make our team better, it has made our equipment managers happier."



Dave Rubio, Head Women's Volleyball Coach
University of Arizona

Model #	Description
VB1000	Complete system includes posts with padding, net tensioning winch, VB1250K competition net with cable covers, antennas with boundary tapes, and VB23 floor sockets.
VB1000NS	Same as VB1000 without floor sockets.
VB1002	Complete side-by-side double court system includes 3 posts with padding, 2 winches, 2 nets, 2 pairs of antennas, and 3 floor sockets.
VB1002NS	Same as VB1002 without floor sockets.
VB10	Posts and winch only. Order padding, net, antennas, and floor sockets separately.
VB100	Court adder increases the number of side-by-side courts and includes post and winch only. Order other components separately. Call for details.



VB1100 **Centerline®** Aluminum EZ

EZ features the same basic design as our popular VB1000 telescoping aluminum Centerline System but with the added convenience of an internal lead screw that allows fine tuning of the net height with the simple turn of a handle on the pole usually with minimal or no net tension reduction. 39# post fits in all manufacturers' 3" floor sockets.



Additional Popular Features on Complete Systems:

- Kevlar Competition Net
- VB13 Antennas and Boundary Tapes
- Rope Ratchet Side Tape Tensioners
- Available as Side-by-Side Court Option
- Free 1 Color Lettered Post Padding
- Free Net Storage Bag
- Free Net Rope Cable Covers
- Free Chain Net Height Gauge
- Free Socket Adapters (on request)
- Order VB51PGUP to Upgrade to Graphic Post Padding

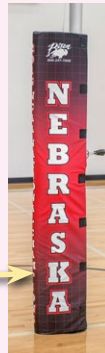

"When bringing the volleyball program back to our school after many years without, we were in need of a modern, reliable, and easy to set up system. Working with our local dealer, we chose Bison VB1100, Centerline EZ system for its lightweight aluminum standards, easy internal net height adjustment system, and free lettered padding. It's great to have volleyball back at Elba Central School, and to be using a great Bison system."



Mark Beehler, Athletic Director
Elba Central School, Elba, New York

Model #	Description
VB1100	Complete system includes posts with padding, net tensioning winch, VB1250K competition net with cable covers, antennas with boundary tapes, and VB23 floor sockets.
VB1100NS	Same as VB1100 without floor sockets.
VB1102	Complete side-by-side double court system includes 3 posts with padding, 2 winches, 2 nets, 2 pairs of antennas and 3 floor sockets plus.
VB1102NS	Same as VB1102 without floor sockets.
VB11	Posts and winch only. Order padding, net, antennas and floor sockets separately.
VB110	Court adder increases the number of side-by-side courts and includes post and winch only. Order other components separately. Call for details.

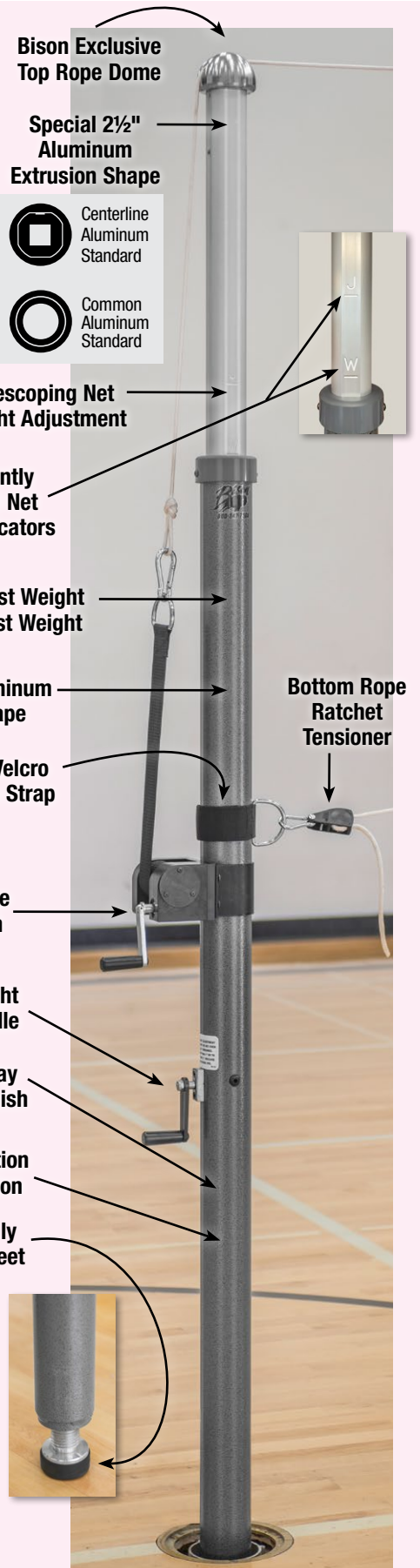



Bison Exclusive Top Rope Dome

Spring Assisted Telescoping Net Height Adjustment

2 1/2" Diameter Aluminum Inner Tube

Permanently Engraved Net Height Indicators

Lock Pin at Junior, Women's and Men's Height

Lock Knob for Infinite Height Adjustment

61# Non-Winch Post Weight
66# Winch End Post Weight

Adjustable Velcro Bottom Rope Strap

Bottom Rope Ratchet Tensioner

Forever™ Lifetime Warranty Winch

3" Diameter Steel Outer Tube

Durable Silver-Gray Powder Coated Finish

1.25" Post Deflection at 250# Net Tension

Floor Friendly Adjustable Feet



VB2000 Centerline® Elite Steel Hybrid

Some programs set up and tear down courts infrequently and prefer the maximum rigidity of a heavy steel system. At 61#, this 3" telescoping post design allows the least pole deflection possible at a cost below comparable carbon fiber or aluminum systems.

Additional Popular Features on Complete Systems:

- Kevlar Competition Net
- VB13 Antennas and Boundary Tapes
- Rope Ratchet Side Tape Tensioners
- Available as Side-by-Side Court Option
- Free 1 Color Lettered Post Padding
- Free Net Storage Bag
- Free Net Rope Cable Covers
- Free Chain Net Height Gauge
- Free Socket Adapters (on request)
- Order VB51PGUP to Upgrade to Graphic Post Padding

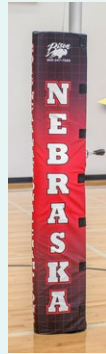

Model #	Description
VB2000	Complete system includes posts with padding, net tensioning winch, VB1250K competition net with cable covers, antennas with boundary tapes, and VB23 floor sockets.
VB2000NS	Same as VB2000 without floor sockets.
VB2002	Complete side-by-side double court system includes 3 posts with padding, 2 winches, 2 nets, 2 pairs of antennas, and 3 floor sockets.
VB2002NS	Same as VB2002 without floor sockets.
VB20	Posts and winch only. Order padding, net, antennas, and floor sockets separately.
VB200	Court adder increases the number of side-by-side courts and includes post and winch only. Order other components separately. Call for details.



VB7222 CarbonLite™ Composite

At 16#, the lightest weight competition volleyball post on the market making it perfect for facilities where set up is frequent. The 3" outer post and telescoping inner post are constructed of computer wound carbon fiber resulting in a superior weight to post rigidity ratio. Fits all manufacturers' 3" floor sockets.



Additional Popular Features on Complete Systems:

- Kevlar Competition Net
- VB13 Antennas and Boundary Tapes
- Rope Ratchet Side Tape Tensioners
- Available as Side-by-Side Court Option
- Free Full Color Graphic Post Padding
- Free Net Storage Bag
- Free Net Rope Cable Covers
- Free Chain Net Height Gauge
- Free Socket Adapters (on request)

"As a long time Bison dealer, we have always appreciated the quality they design into every product. As the volleyball industry moved toward light weight carbon fiber poles, we looked to Bison to fill our needs. The Bison CarbonLite Volleyball System has more than satisfied our customers who are looking for an extremely light weight yet rigid and durable system for their courts."

Paul Speth, President
Badger Sporting Goods, Madison, WI

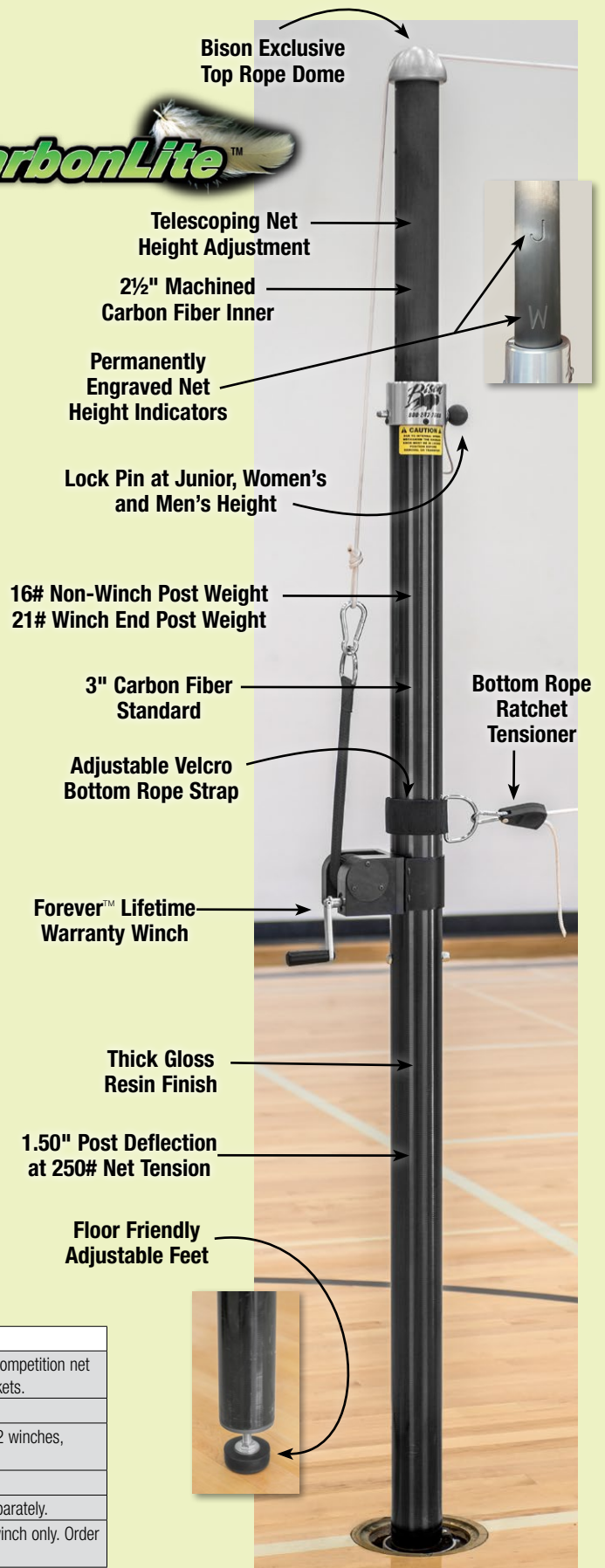

Model #	Description
VB7222	Complete system includes posts with padding, net tensioning winch, VB1250K competition net with cable covers, antennas with boundary tapes, and VB23 floor sockets.
VB7222NS	Same as VB7222 without floor sockets.
VB7202	Complete side-by-side double court system includes 3 posts with padding, 2 winches, 2 nets, 2 pairs of antennas, and 3 floor sockets.
VB7202NS	Same as VB7202 without floor sockets.
VB72	Posts and winch only. Order padding, net, antennas, and floor sockets separately.
VB722	Court adder increases the number of side-by-side courts and includes post and winch only. Order other components separately. Call for details.





VB7000 CarbonMax® Composite

The only carbon fiber volleyball system with a crank style internal net height adjustment feature for easy and accurate net fine tuning. 32# post fits in 3" floor sockets.

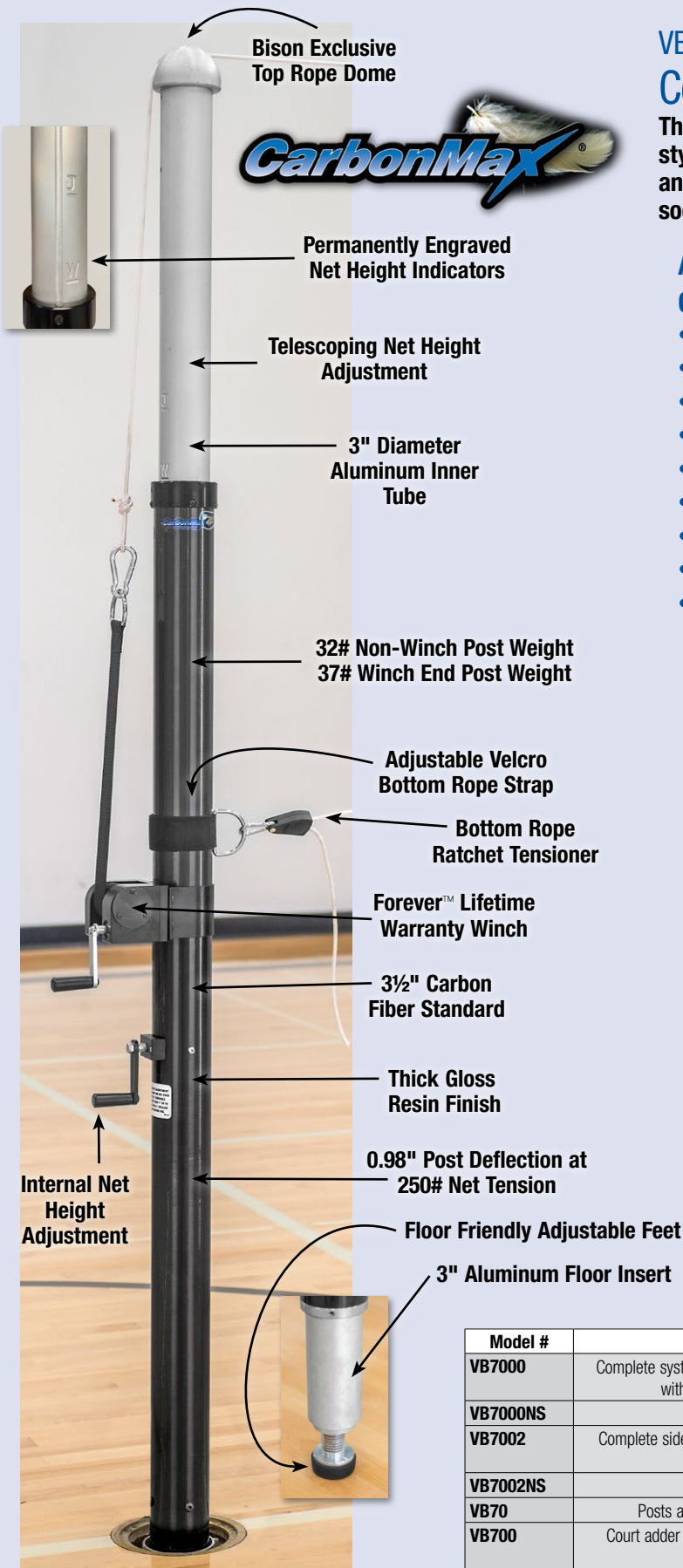

Additional Popular Features on Complete Systems:

- Kevlar Competition Net
- VB13 Antennas and Boundary Tapes
- Rope Ratchet Side Tape Tensioners
- Available as Side-by-Side Court Option
- Free Full Color Graphic Post Padding
- Free Net Storage Bag
- Free Net Rope Cable Covers
- Free Chain Net Height Gauge
- Free Socket Adapters (on request)



"Our Division I program is a perennial National Championship contender, and we work hard to provide our players with superior equipment. As a longtime user of Bison Centerline Elite Aluminum Systems, we thought

we had the best... that was until we discovered CarbonMax. Our equipment manager loves the lightweight design that doesn't compromise on rigidity. The ability to adjust the net height with the turn of a crank without loosening the net is an added bonus."

John Cook Head Women's Volleyball Coach, University of Nebraska 2017 NCAA Division I Champions, and AVCA Hall of Fame Member

Model #	Description
VB7000	Complete system includes posts with padding, net tensioning winch, VB1250K competition net with cable covers, antennas with boundary tapes, and VB23 floor sockets.
VB7000NS	Same as VB7000 without floor sockets.
VB7002	Complete side-by-side double court system includes 3 posts with padding, 2 winches, 2 nets, 2 pairs of antennas, and 3 floor sockets.
VB7002NS	Same as VB7002 without floor sockets.
VB70	Posts and winch only. Order padding, net, antennas, and floor sockets separately.
VB700	Court adder increases the number of side-by-side courts and includes post and winch only. Order other components separately. Call for details.



VB3000 Lady CarbonMax Composite

This one-piece 100% carbon fiber post is the popular choice for facilities that want a system exclusively for use at women's net height. With no net height adjustment to worry about, set up is quick and foolproof. 19# post installs in any 3" floor sockets.

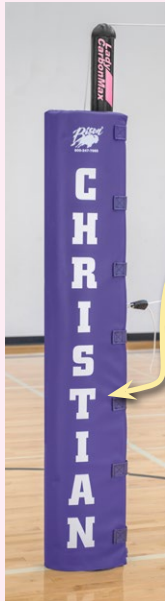

Additional Popular Features on Complete Systems:

- Kevlar Competition Net
- VB13 Antennas and Boundary Tapes
- Rope Ratchet Side Tape Tensioners
- Available as Side-by-Side Court Option
- Free 1 Color Lettered Post Padding
- Free Net Storage Bag
- Free Net Rope Cable Covers
- Free Chain Net Height Gauge
- Free Socket Adapters (on request)
- Order VB51PGUP to Upgrade to Graphic Post Padding

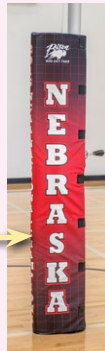

"Our volleyball coach loves Bison's Lady CarbonMax composite volleyball system. We've used this system for a few seasons now and are pleased with its trouble-free performance. The standards are very easy to set up, they're lightweight and dependable."



Bill Clements Activities Director, Dakota Valley High School
North Sioux City, SD

19# Non-Winch Post Weight
24# Winch End Post Weight

3½" Carbon Fiber Standard

Adjustable Velcro Bottom Rope Strap

Forever™ Lifetime Warranty Winch

Thick Gloss Resin Finish

1.25" Post Deflection at 250# Net Tension

Floor Friendly Adjustable Feet

3" Aluminum Floor Insert

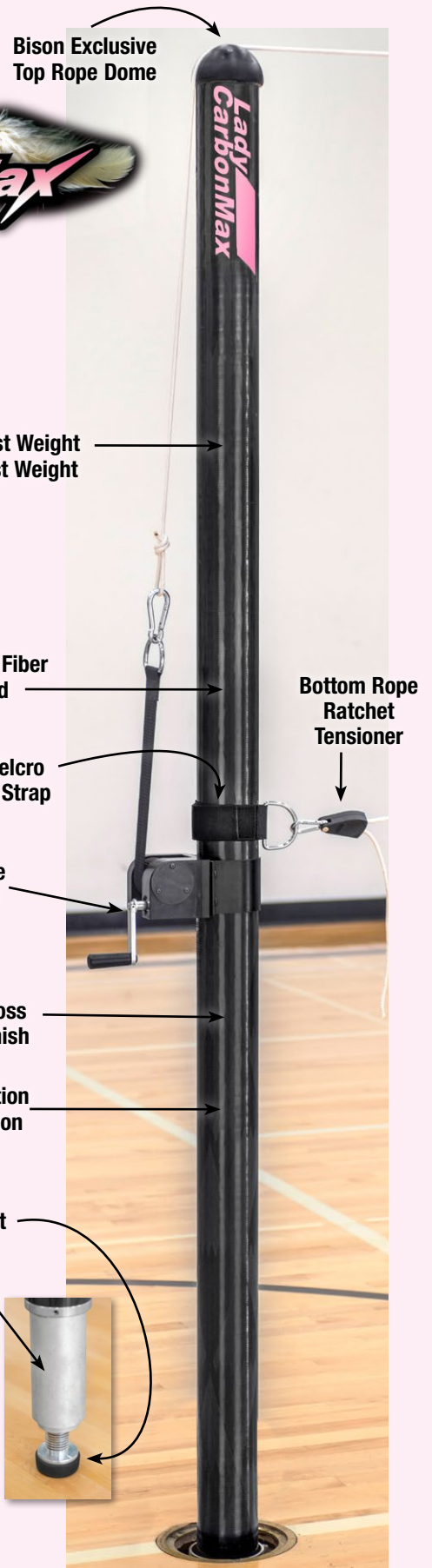

Model #	Description
VB3000	Complete system includes posts with padding, net tensioning winch, VB1250K competition net with cable covers, antennas with boundary tapes, and VB23 floor sockets.
VB3000NS	Same as VB3000 without floor sockets.
VB3002	Complete side-by-side double court system includes 3 posts with padding, 2 winches, 2 nets, 2 pairs of antennas, and 3 floor sockets plus.
VB3002NS	Same as VB3002 without floor sockets.
VB30	Posts and winch only. Order padding, net, antennas, and floor sockets separately.
VB300	Court adder increases the number of side-by-side courts and includes post and winch only. Order other components separately. Call for details.



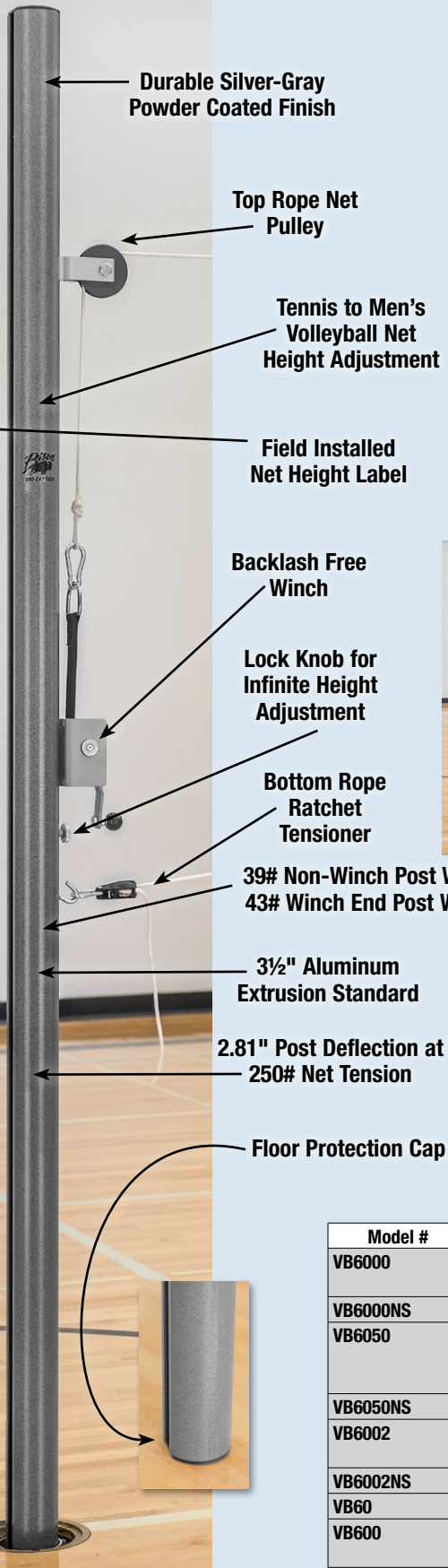

Durable Silver-Gray Powder Coated Finish

Top Rope Net Pulley

Tennis to Men's Volleyball Net Height Adjustment

Field Installed Net Height Label

Backlash Free Winch

Lock Knob for Infinite Height Adjustment

Bottom Rope Ratchet Tensioner

39# Non-Winch Post Weight
43# Winch End Post Weight

3/2" Aluminum Extrusion Standard

2.81" Post Deflection at 250# Net Tension

Floor Protection Cap

VB6000 Match Point™ Aluminum

Designed for high schools on a budget, rec centers or any facility that wants a lightweight yet durable power volleyball system. The unique 43" to 96" infinite net height adjustment track allows competition volleyball and PE tennis or pickleball on the same system. The 39# post fits in all 3 1/2" diameter floor sockets.

* Ask about adapters for smaller existing floor sockets.

Additional Popular Features on Complete Systems:

- Kevlar Competition Net
- VB13 Antennas and Boundary Tapes
- Rope Ratchet Side Tape Tensioners
- Available as Side-by-Side Court Option
- Free 1 Color Lettered Post Padding
- Free Socket Adapters (on request)
- Substitute VB60C and VB600C Posts for use in Existing 1 7/8" Floor Sockets
- Order VB51PGUP to Upgrade to Graphic Post Padding

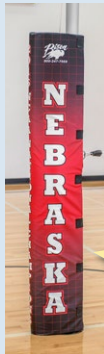

"When we were looking for an affordable yet durable, versatile, and easy to set up volleyball system for our volleyball program, we stumbled onto the Bison VB6000 Match Point, aluminum system. Our volleyball coaches are extremely pleased with the performance, and it is the perfect fit for our program and our budget."



Jeff Hines

Dean of Students, Chambers Academy
Lafayette, Alabama

Model #	Description
VB6000	Complete system includes posts with padding, net tensioning winch, VB1250KU competition net, antennas with boundary tapes, and VB26 floor sockets.
VB6000NS	Same as VB6000 without floor sockets.
VB6050	Recreational system includes posts, net tensioning winch, VB1250KU competition net, and VB21 floor sockets for tile, concrete, or synthetic floors (upgrade to VB26 floor sockets for floating floors at an additional cost).
VB6050NS	Same as VB6050 without floor sockets.
VB6002	Complete side-by-side double court system includes 3 posts with padding, 2 winches, 2 nets, 2 pairs of antennas, and 3 VB26 floor sockets.
VB6002NS	Same as VB6002 without floor sockets.
VB60	Posts and winch only. Order padding, net, antennas, and floor sockets separately.
VB600	Court adder increases the number of side-by-side courts and includes post and winch only. Order other components separately. Call for details.



VB8100 **Arena II™** Freestanding Portable

Large arenas and multiuse facilities where elite level volleyball is played but where floor sockets or anchors are difficult, expensive or impossible due to ice rink refrigerant lines, portable flooring systems, upper floor location or other constraints may find this system an excellent option.

Popular Features on Complete Systems:

- Kevlar Competition Net
- VB13 Antennas and Boundary Tapes
- Rope Ratchet Side Tape Tensioners
- Available as Side-by-Side Court Option
- Free 1 Color Lettered Padding
- Free Net Storage Bag
- Free Net Rope Cable Covers
- Free Chain Net Height Gauge



Forklift or dock required for delivery. Contact Bison for other off-loading options.

NO ANCHORS NEEDED



"We've used the Bison Centerline Aluminum Volleyball System for years in our program and have loved it. A major facility renovation forced us to move to temporary quarters for a season and we faced the dilemma of using a portable floor in a facility with no floor sleeves. Bison's Arena II Volleyball System worked perfectly for us. It provided us the free standing portability needed without sacrificing net rigidity, ease of set up, player safety or overall quality. And, it looks AWESOME!"



Debbie Brown
Former Head Volleyball Coach,
University of Notre Dame and AVCA Hall of Fame Member

VB810 Arena™ Court Adder

Want more side-by-side courts?...Order as many Arena Court Adder center posts as you wish • Each court adder includes base, pole, net tensioning winch and transport dolly • Order net, antennae and VB810P padding system (specify color) separately • Only for use as center post on Arena II, Arena Jr and QwikCourt Volleyball Systems • **Lifetime limited warranty** on post and winch (no pole or padding) • **Order VB810P for complete Arena Court Adder base and post padding** • **Order VB810BASE for base only.**



VB810

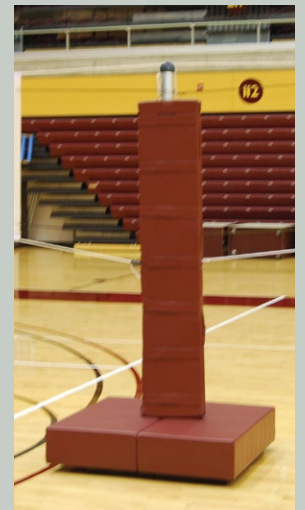

VB810P

Model #	Description
VB8100	Complete system includes internally-ballasted "down official" and "platform" end bases with padding, net tensioning winch, VB1250K competition net with cable covers, and antennas with boundary tapes.
VB8102	Complete side-by-side double court system includes end bases with padding, padded center post with transport dolly, 2 winches, 2 nets, and 2 pairs of antennas.
VB8102DJ	Same as VB8102 except both end bases have built-in official's platforms.
VB810	Center post and winch with transport dolly. Add any number of side-by-side courts to VB8100, VB8102, or VB8102DJ. Order VB810P center post padding, nets, and antennas separately.



800-247-7668



www.bisoninc.com



Order optional VB73A Officials Platform (shown) separately.

VB810 Arena™ Court Adder

Want more side-by-side courts?...Order as many Arena Court Adder center posts as you wish • Each court adder includes base, pole, net tensioning winch and transport dolly • Order net, antennae and VB810P padding system (specify color) separately • Only for use as center post on Arena II, Arena Jr and QwikCourt Volleyball Systems • **Lifetime limited warranty** on post and winch (no pole or padding) • **Order VB810P for complete Arena Court Adder base and post padding** • **Order VB810BASE for base only.**



VB810

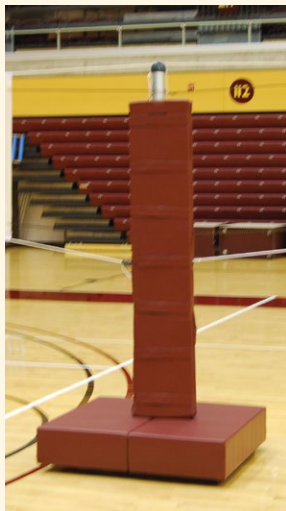

VB810P

VB8100JR **Arena™ JR** Freestanding Portable

Truly portable with no anchor or loose ballast and a super streamlined base. Complete system includes 3" Centerline® aluminum pole system that can be used both in the bases and in gym floor sockets. Order just the VB80JR padded bases to use with your own 3", 3½" or 4" poles.

Substitute VB10T/VB100T for shortened posts if you intend to use posts only in the portable bases.

Popular Features on Complete Systems:

- Kevlar Competition Net
- VB13 Antennas and Boundary Tapes
- Rope Ratchet Side Tape Tensioners
- Available as Side-by-Side Court Option
- Free 1 Color Lettered Post Padding
- Free Net Storage Bag
- Free Net Rope Cable Covers
- Free Chain Net Height Gauge

Forklift or dock required for delivery. Contact Bison for other off-loading options.



"The Nebraska School Activities Association highly recommends Bison's Arena Jr. portable system. The system is perfect for the NSAA State Volleyball Championships held at Pinnacle Bank Arena as there is no need for anchors or loose ballast, is easy to setup, and provides great net tension with an unobstructed view for fans and coaches."

Jennifer Schwartz
NSAA Associate Director

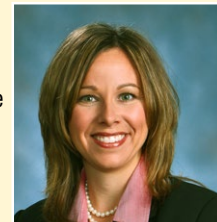

Model #	Description
VB8100JR	Complete system includes 2 end bases with transport dolly, 2 posts, net tensioning winch, VB1250K competition net with cable covers, and antennae with boundary tapes.
VB8102JR	Complete side-by-side double court system includes 2 padded end bases with transport dolly, 1 padded center post with transport dolly, 3 posts with padding, 2 winches, 2 nets, and 2 pairs of antennae.
VB810JR	Center post base, post and winch only. Add any number of side-by-side courts to VB8100JR. Order VB810P padding, nets, and antennae separately.
VB80JR	One pair of bases with base and post padding only. Customer supplies posts, net, and antennae.

VB8200/VB8250

QwikCourt™ Portable

Bison's lowest cost self-contained portable volleyball base system. Perfect for use where socket installation is not feasible but an affordable competition or recreational volleyball system is needed for long term or temporary use. Bases can be used with virtually any post system.

VB8200 QwikCourt™ Centerline

When your facility needs a relatively low cost competition system in areas where floor sockets are impractical or impossible.

VB8250 QwikCourt™ Match Point

When you want a reliable portable volleyball system for recreational use when floor sockets are not available.

VB82P Optional Colored Padding System for QwikCourt

Substitute one of the colors of padding found on page 93 of catalog for the standard black padding on QwikCourt at an additional cost.

Popular Features on Complete Systems:

- Kevlar Competition Net
- VB13 Antennas and Boundary Tapes
- Rope Ratchet Side Tape Tensioners
- Free 1 Color Lettered Post Padding
- Free Net Storage Bag
- Free Net Rope Cable Covers
- Free Chain Net Height Gauge
- Free Socket Adapters (on request)



Model #	Description
VB8200	Complete system includes 2 end bases with padding, 2 3" Centerline Aluminum posts with padding, net tensioning winch, VB1250K competition net with cable covers, and antennas with boundary tapes.
VB8250	Same as VB8200 except includes 3½" Match Point Aluminum volleyball posts.
VB82	One pair of bases with base and post padding only. Customer supplies posts, net, and antennas.



800-247-7668



www.bisoninc.com



VB1000T Centerline™ Portable Systems

College or high school programs that want all the features of an elite system but find floor socket installation is impossible or impractical. This system only requires installation of four easy-to-install threaded floor anchors

VB6000T Match Point™ Portable Systems

Budget conscious programs that need portability but won't sacrifice playability. Floor anchors are easier and less costly to install than floor sleeves required on typical in-floor systems.

Popular Features on Complete Systems:

- Kevlar Competition Net
- VB13 Antennas and Boundary Tapes
- Rope Ratchet Side Tape Tensioners
- Free 1 Color Lettered Post Padding
- 4 each VB25FL Floor Anchors (Substitute VB25 or VB25TF below at no extra cost)
- Includes Reduced Height Posts

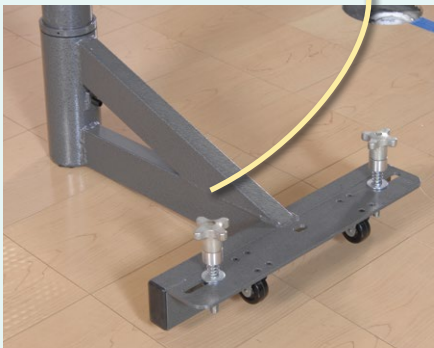

VBTBASE T-Base Adapter Only

Convert virtually any 3", 3½" or 4" volleyball standards into a portable system... Without sacrificing net tensioning • Purchase separately or in complete systems VB1000T or VB6000T above • Eliminates the need to install costly and sometimes impractical or impossible floor sockets for traditional posts • Order four Bison floor anchors separately (VB25, VB25FL or VB25TF) based on gym flooring system • Features heavy steel construction, floor friendly transport wheels, easy-to-use, built-in floor attachment knobs and durable powder coated finish • If ordered without poles, customer will need to order two VB354 sleeve adapters for any 3½" pole system or two VB340 sleeve adapters for any 3" pole system • Order VBTBASEP for Base Padding.

T-BASE ADAPTOR FLOOR ANCHOR OPTIONS



VB25 Standard Drill-In Floor Anchor

Allows anchoring of portable volleyball or basketball systems to existing concrete, synthetic or tile floors without major concrete excavation... Provides ½" threaded hole with spring loaded plug • Requires core drilling and grouting.



VB25FL Drill-In Anchor for Common Floating Floors

Same as VB25 except with flange to add additional anchor support when installed on floating maple floor systems... Includes all necessary hardware • Requires concrete core drilling, routing of wood floor and grouting of anchor into concrete • Provides ½" threaded hole with spring loaded plug.



VB25TF Thin Slab Drill-In Floor Anchor

Wide range of thin slab applications... Use on athletic floors that have playing surface installed

directly over a concrete surface such as tile or synthetic and where the concrete is too thin to allow the use of VB25 or VB25FL • Same ½" threaded insert hole with spring loaded plug • No hardware is provided as this anchor is used in a wide range of applications • Consult a Bison Product Specialist.





SVB5050W Match Point™ Post or Wall Mounted Volleyball System

All the features of Bison's popular Match Point systems on a convenient track system...Track system mounts to customer's supplied posts, walls or any surface strong enough to support desired net tensioning • Net can be infinitely adjusted from 42" (tennis) to 96" (men's volleyball) net height • System includes VB1250K competition volleyball net, net tensioning winch, net storage bag and net cable covers • Order **VB13** boundary antennae separately • Tracks must be mounted between 34' and 40' apart to be compatible with net provided • With customer supplied net rope extension tracks could be mounted wider but net might sag or require additional supports to maintain net height

- Five-year limited warranty on track and winch.



VB9130, VB9135, VB9140 Volleyball Pole Caddies

Make transport of your volleyball poles easy and safe...fits any manufacturer's poles • 3" floor friendly wheels and 8" tall receiver socket • Choose **VB9130** for 3" poles, **VB9135** for 3½" poles or **VB9140** for 4" poles.



VB94 Volleyball Four Post Transport Cart

Heavy-duty design allows compact and easy storage and transport of up to two complete volleyball systems...Compatible with any brand of 3", 3½" or 4" outside diameter posts • Non-marking, 4" swivel casters • Bonus storage for net and padding • Durable, white powder coated finish • Reduces damage to posts and floor • Total width when loaded is 30", allowing transport through most doors • Eliminates multiple trips from storage to set up equipment • One-year limited warranty.



VB96 Six Post Deluxe Volleyball Cart

Easy loading, easy transport, easy storage...For all your volleyball program's needs • Safely and securely holds 6 padded posts or up to 12 without padding • Versatile fabric cradle holds nets, antennae, cable covers, balls or padding • Top storage rack can hold officials stand or padding allowing everything you need to be wheeled through a 36" wide door • Sturdy powder coated steel structure with 4" floor friendly, swivel casters for easy movement • Five-year limited warranty.



VB92 Volleyball Standard Wall Storage Rack

Keep any 3" to 4" diameter volleyball standards safely stored without damage...Order one VB92 for each pair of standards • Mount to any wall with customer supplied mounting hardware.





VB51P



VB51PL



VB51PG

Volleyball Post Padding

Multiple options to protect your players...all meeting NCAA, National High School Federation, USVBA and FIVB rules • All padding is constructed of 1" thick high density foam, sewn 14oz vinyl and hook and loop closures and covers posts to a height of 6' • Designed to fit Bison volleyball standards but will fit most other manufacturers' floor socket style posts • Sold in pairs except VB510P Center Post Padding • Five year limited warranty.

VB51P Solid Color Padding

Choose any of the colors of vinyl shown on page 95.

VB51PL Universal Lettered Padding

Choose from any of our vinyl colors shown on page 79 then add up to 10 letters on all four sides of the padding in your choice of lettering styles shown on page 95 • Consult the Bison Art Department if you wish to upgrade to two-color lettering • Far superior to vinyl lettering adhered to padding.

VB51PG Full Color Graphic Padding

Virtually any color or design can be created with the assistance of our Art Department staff • Durable UV inks on 14 oz. vinyl • May require a BNART artwork design charge • Allow 3-4 weeks for delivery • Order **VB51PGUP** to upgrade free lettered padding included in some complete Bison volleyball packages.

VB510P Center Post Padding

Designed specifically to cover the center post on side-by-side courts when nets are attached to both sides of post • Due to design, center post padding cannot be lettered or graphically printed • Choose from colors on page 95 • Sold individually.



VB1250SP Sport Pride™ Volleyball Net Band

See your program's name or logo on the sports page...

Customize this add-on white net tape • Attaches onto any manufacturer's net in less than five minutes with hook and loop fasteners • Now with improved flexibility and print durability • Full-color logo or lettering on a white background • Permanent ink for lasting school spirit • Remove and reinstall as you replace nets • Complete with off season storage reel • One-year limited warranty.



Net Band Storage Reel

VB1250TR In the Zone™ Training Net Tape

Position players and every set in easy to read colored zones during practice to get the most of every ball possession...Hook and loop band installs and is removed easily from any manufacturer's competition net when not in use • Complete with storage reel • One year limited warranty.



VB1250ST School Spirit™ Side Tape Covers

Show your school pride...See your school name on the sports page or TV highlights • Hook and loop attached side tapes have a white background • Select from letter styles below • See page 79 for color options (one color only) • 10 letters maximum, 24" x 2" imprint area • Printed on both sides • Sold in pairs (per net) • Fits most manufacturers' competition nets • One-year limited warranty.

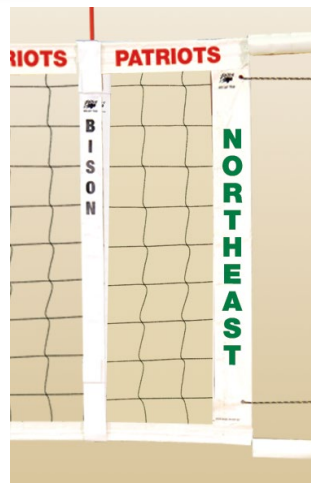

VB1250K Kevlar Competition Volleyball Net

Designed specifically to install easily and bowstring tight on most Bison competition volleyball systems...features include no stretch Kevlar top rope, tenex bottom rope with rope ratchet tensioner, knotless woven webbing, heavy white vinyl side tapes, ratchet style side tape tensioning devices and extra-long top and bottom ropes to allow use on volleyball systems with posts spaced from 35' to 45' apart • Official size 32' x 1 meter net meets all NCAA, USVBA, FIVB and National High School Federation rules • Net includes four top and bottom rope cable covers and a zippered storage bag • Two-year limited warranty.

VB1250KU Universal Competition Kevlar Volleyball Net

Similar design as VB1250K Competition net above...great spare net for practice or competition • Compatible with not only Bison systems but also can be used on most other manufacturers' net systems • Use on volleyball systems with posts spaced from 35' to 45' apart • Features include heavy white side tapes, knotless mesh, Kevlar top rope, bottom rope with rope ratchet and set of four ratchet style side tape tensioners • One-year limited warranty.

FREE Zippered Net Storage Bag
with purchase of a VB1250K Net



SVB1250K Official Kevlar Sand Volleyball Net

Same high quality competition net as VB1250K above except...official 8.5 m (28') long
• One-year outdoor warranty.

VB123 NetSet™ Volleyball Net Tensioning Gauge

Never guess at proper net top rope tension again...Find the best tension setting for your system and count on an exact repeat every time • Gauge installs between the winch and the top rope on all Bison and most manufacturers' competition systems • Easy-to-read 1-2-3 tension indicators • Mark your desired setting with a permanent marker so no matter who sets up the system, it will be the same as the last time • Anodized aluminum body, chromium steel spring, red line indicator, plated steel internal plunger and heavy-duty spring clip connectors • Two-year limited warranty.



See YouTube.com/bisoninc for Product Videos



VB98HG Chain Net Height Gauge

Eliminate the need for tape measures or bulky poles with this easy-to-use chain net gauge...Multiple indicators for all common net heights • Complete with small zippered storage bag, instructions and spring clip to store gauge behind padding attached to the pole or net rope.

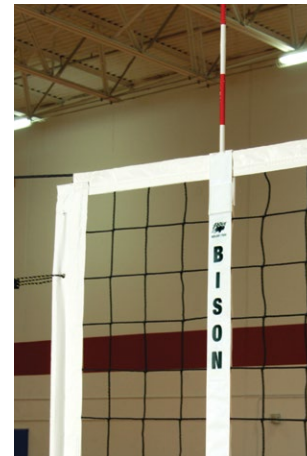

VB13 SideLine™ Antennas

Clearly mark court boundaries with this combination antennas and bright white boundary tape...Attaches easily with hook and loop fasteners • Two-piece antennas self-store in boundary tape storage pocket allowing antennas to remain attached to net when removed from posts • Fits both 1 meter and 36" high nets • Meets all NCAA, National High School Federation, FIVB and USVBA rules • Order **VB13SL** for replacement boundary tapes (without antennas) • 90-day limited warranty.

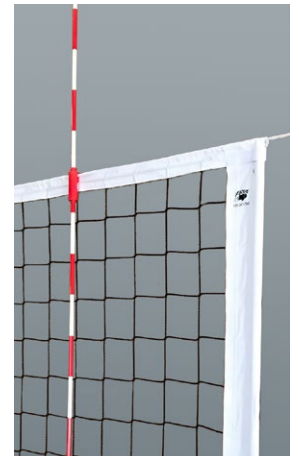

VB17 ASICS® International Volleyball Net Antenna

The net antenna preferred by some coaches and equipment managers...This antenna attaches easily and securely by means of two threaded tensioners • Fiberglass red/white rods • Adjustable to fit both 36" and 1 meter (39.37") nets • Meets all NCAA, NF and FIVB rules • Sold in pairs • ASICS is a registered trademark of ASICS Corporation • 90 day limited warranty.





Clamp in Storage Position



Clamp in Use Position



VB73A Adjustable Clamp-On Officials Platform

Popular design is compatible with most manufacturers' volleyball systems... whether 3", 3½" or 4" • Integrated ratchet style clamp device attaches platform to pole quickly and securely • Comfortable width platform adjusts in 1" increments from 47" to 53" height for officials and play at all net heights • Standard gray 1" thick player protection padding meets all NCAA, National High School Federation, USBA and FIVB rules • Transports on two floor friendly urethane wheels and rests on non-skid rubber floor pads when in use • Powder coated 1" heavy wall tube construction • Black, Maroon, Navy, Royal and Scarlet padding is available at no additional cost • Order **SVB73** for use on sand volleyball courts • Five-year limited warranty.



VB76 Freestanding Folding Officials Platform

The perfect balance of stability and storability... meets all NCAA, National High School Federation, USVBA and FIVB rules • Easy pull pin folding design • Powder coated heavy-duty steel construction • Floor friendly wheels and floor pads • Standard gray padding system but substitute Black, Maroon, Navy, Royal and Scarlet at no additional cost • One-year limited warranty.

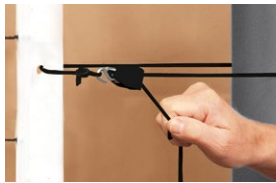

VB1200RR Rope Ratchet Net Tensioning Kit

Replace or supplement side tape tensioning devices... set of four rope ratchet tensioners will provide bowstring tight net tensioning on Bison or many other manufacturers' competition volleyball nets • Pull rope through ratchet to tension and easily release without tools.

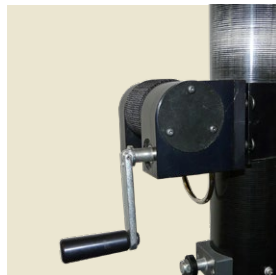

Replacement 26:1 Centerline™ Volleyball Winch

Replace your net top rope tensioning winch on your Bison system or on other manufacturers' 3" or 3½" outside diameter volleyball systems • Computer machined backlash free winch with folding handle will provide up to 250# of top rope net tension on any manufacturer's net • Includes post attachment clamp • Order **VB10W30** to mount to 3" diameter posts, order **VB10W35** to mount to 3½" diameter posts • Five-year limited warranty.



VB60W Replacement Match Point™ Volleyball Winch

Replace your net top rope tensioning device... on Bison Match Point™ volleyball systems. One-year limited warranty.

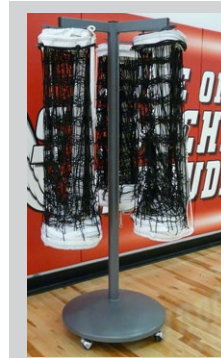

VB1253W Net Storage Winder

Tired of wadded up, dirty, and tangled volleyball nets?...Here is your answer • Roll and store nets when not in use • 24" dome base has non marking wheels to roll easily to and from storage • Nets hang neatly and dependably on rotating top spider • Stores up to 3 nets.



VB1250KRR Replacement Bottom Rope Ratchet for Bison Volleyball Nets

Pull rope through ratchet... release without tools.



VBHOOK/LOOP Replacement Bottom Net Rope Collars

Use to replace lost collars that came with most Bison volleyball systems. Sold in pairs.



VB35P Replacement Volleyball Net Cable Covers

Includes set of 4.





VB23, VB26, VB27
Hinged Brass



VB235, VB21, VB22
Plated Aluminum

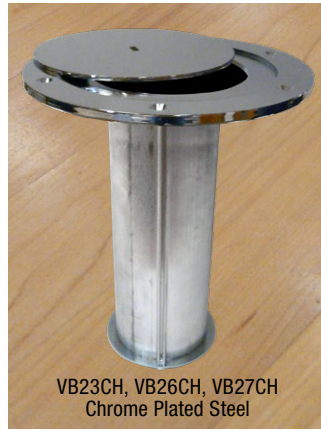

VB23CH, VB26CH, VB27CH
Chrome Plated Steel



VB23LK, VB26LK, VB27LK
Lockable Hinged Brass



BM21
Small Hinged Brass

Bison Premium Floor Sockets

Volleyball and badminton systems come in multiple sizes, all gym flooring systems are not the same and every facility has different floor cover priorities. Bison has a premium floor socket for every application.

All Bison floor sockets start with Bison's exclusive aluminum extrusion that not only eliminates rust but eliminates the sloppy fit found with other manufacturers' welded steel floor sockets. Bison now offers 3" and 3½" steel floor sockets if preferred (see below).

A unique shimming system allows Bison volleyball floor sockets to easily install in the floor at an approximate 2% outward angle to compensate for post deflection found on even the most rigid steel systems.

Floor plates are available in four different styles including our most popular hinged brass, lockable hinged brass, swiveling chrome plated steel and plated aluminum. With our mini hinged brass badminton socket cover, you won't have to have oversize covers in your gym floor.



VB23-CV Hinged Brass



VB23CH-CV Chrome Plated Steel



VB23LK-CV Lockable Hinged Brass



BM30-CV Small Hinged Brass

Floor Socket Cover Plates Only

Replace existing worn out or damaged floor plates or install to provide easy access to subfloor electrical plugs, anchors or other hidden components. Choose from four options.



VB23ST/VB26ST Steel Floor Sockets with Hinged Brass Covers

Bison now offers steel 3" (VB23ST) and 3½" (VB26ST) floor sockets as a substitute for our preferred extruded "proper fit" aluminum sockets

- Same hinged brass floor plate as VB23 and VB26
- You can now choose either aluminum or steel sockets at the same cost.

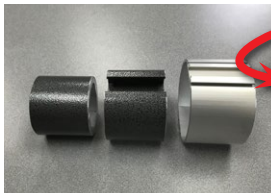

FREE! Upon Request Floor Socket Gauge Kit

Aren't 100% sure of your existing volleyball floor socket size?....these sample pole sizes will guarantee that you select the right size poles to fit your sockets. Set of 3 (3", 3½", 4").

See YouTube.com/bisoninc for Product Videos 

Floor Socket Selection Chart

Floor Plate Style	Floor Type	Cover OD	Cover Opening	Cover Only	1¼" Square Socket	23/8" Diameter Socket	Aluminum 3" Diameter Socket	Steel 3" Diameter Socket	Aluminum 3½" Diameter Socket	Steel 3½" Diameter Socket	Aluminum 4" Diameter Socket
Large Hinged Brass	Floating Wood	8"	6"	VB23-CV	N/A	N/A	VB23	VB23ST	VB26	VB26ST	VB27
Large Lockable Hinged Brass	Floating Wood	8"	6"	VB23LK-CV	N/A	N/A	VB23LK	N/A	VB26LK	N/A	VB27LK
Large Swivel Chrome Plated Steel	Floating Wood	8"	4½"	VB23CH-CV	N/A	N/A	VB23CH	N/A	VB26CH	N/A	VB27CH
Large Plated Aluminum	Non Floating Tile, Concrete, Synthetic	7½"	4"	N/A	N/A	VB24	VB235	N/A	VB21	N/A	VB22
Small Hinged Brass	Floating Wood	4½"	3"	BM30-CV	BM21	N/A	N/A	N/A	N/A	N/A	N/A
Socket Depth	N/A	N/A	N/A	N/A	12"	12.5"	10"	10"	10"	10"	13"



800-247-7668



www.bisoninc.com

55

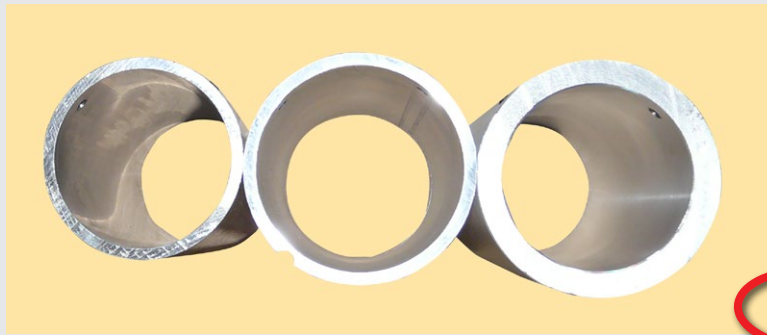

Volleyball Sleeve Reducers

Install 3" diameter or 3½" diameter volleyball posts in any manufacturer's 4" or 3½" floor sockets...Machined aluminum for a rattle free fit, each sleeve has two setscrews to allow it to be affixed to either the floor sleeve or to the pole depending on the facility's preference • Select **VB354** to install 3½" posts in 4" sockets, select **VB340** to install 3" posts in 4" sockets, select **VB335** to install 3" posts in 3½" sockets, select **VB340F** to install 3" posts in 4" diameter sockets that are in excess of 10" deep.

FREE! Upon Request

(with complete system orders, some restrictions apply)

VBDSS Socket Depth Adapter (not shown)

If your existing sockets are extra deep...You may need depth adapters to allow proper installation of your volleyball poles • Bison will provide, free of charge, custom depth adapters with the purchase of any Bison volleyball system • Provide diameter and depth of existing sockets and model of Bison system.

See YouTube.com/bisoninc for Product Videos

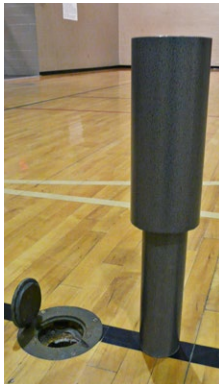

Oversize Volleyball Post Adapters

You can now install 3½" or 4" diameter volleyball posts in gyms with 3" or 3½" existing floor sockets...3 models to choose from • Welded steel construction • Powder coated finish • Select **VB4035** to install 4" posts in 3½" sockets • Select **VB4030** to install 4" posts in 3" sockets • Select **VB3530** to install 3½" posts in 3" sockets • Sold in eights • Note that since the bottom of the pole will now be at the approximate height of the gym floor, the pole will extend 8" – 10" more than usual above the floor • One-year limited warranty.

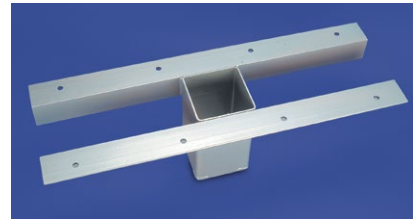

VB230 Second Story Volleyball Socket Form

Just what you need to install volleyball sockets in floors with lower level or crawl space directly below volleyball court... Prefabricated form can be used as is or field modified • Use in conjunction with any Bison floor socket • Heavy welded steel with powder coated finish • Requires experienced installer for proper use.



VB25 Standard Drill-In Floor Anchor

Allows anchoring of portable volleyball or basketball systems to existing concrete, synthetic or tile floors without major concrete excavation... Provides ½" threaded hole with spring loaded plug • Requires core drilling and grouting.



VB25FL Drill-In Anchor for Common Floating Floors

Same as VB25 except with flange to add additional anchor support when installed on floating maple floor systems... Includes all necessary hardware • Requires concrete core drilling, routing of wood floor and grouting of anchor into concrete • Provides ½" threaded hole with spring loaded plug.



VB25TF Thin Slab Drill-In Floor Anchor

Wide range of thin slab applications... Use on athletic floors that have playing surface installed

directly over a concrete surface such as tile or synthetic and where the concrete is too thin to allow the use of VB25 or VB25FL • Same ½" threaded insert hole with spring loaded plug • No hardware is provided as this anchor is used in a wide range of applications • Consult a Bison Product Specialist.

VB231K Hinged Brass Floor Plate Cover Installation Kit

Install Bison Hinged Brass Floor Socket Covers with professional results...Two-piece router template kit can be used over and over for perfectly sized pockets in floating wood floors • One ¼" shank router bit included • Customer supplies router • Order **VB231KRB** for replacement router bits.



Thru Hole Template



Step Bore Template



SVB1000 Centerline® Elite Sand Volleyball System

You supply the sand...Bison will supply the rest • You won't need to sacrifice ease of setup, safety or net tensioning with Bison's Centerline Elite Sand Volleyball Systems • Bison's exclusive TwistLock™ removable stainless steel sand sockets not only allow easy removal of posts when not in use but also eliminate the problem of sand or water filling the socket • Centerline Sand Volleyball posts have all the great features that have made Centerline Elite a standard in the industry plus special features for outdoor and indoor sand court use including stainless steel hardware and other weather and sand proofing features • As an added bonus, the same 3" Centerline posts can be used indoors on your hardwood floor court and outdoors without modifications for maximum equipment utilization • Complete system includes special Centerline 3" sand aluminum posts, lifetime warranty net tensioning winch, competition TwistLock stainless steel sockets, player safety padding (see page 95 for color options), competition Kevlar top rope net (substitute SVB1250K for VB1250K for installation at official 8.5M 2 on 2 sand volleyball play) antennae, net and antennae storage bag, net rope cover and net height indicator • You'll also get FREE post pad lettering on all complete system orders • Order **SVB73** Sand Volleyball Officials Stand and boundary kit separately • Systems meet all applicable high school and college rules.

SVB1250K Competition Sand Volleyball Net

Our VB1250K top quality Kevlar top rope net with heavy white side tapes except shortened to 8.5 meters for official NCAA 2-on-2 sand volleyball • One-year limited warranty.

SVB1002 Centerline Side-by-Side Double Court Sand Volleyball Systems

Need two courts but want to save money?...Bison side-by-side courts are the answer • Three posts, two net tensioning winches, three TwistLock sand ground sockets, two nets, two antenna and post padding are all included in this complete package • As an added bonus, free pad lettering on the outside end posts, free net and antenna storage bag and free net chain net height indicator makes this a truly complete package.

SVB100 Centerline Sand Volleyball Court Adder

Need even more side-by-side courts?...Purchase one court adder plus additional VB1250K nets, VB510P post padding, VB13 antennae/boundary markers and SVB23 sand ground sockets to string as many courts together as desired • Each SVB100 includes one Centerline Elite Sand Volleyball post and lifetime warranty net tensioning winch • Order **SVB10** for replacement pair of Centerline sand volleyball posts with winch only.

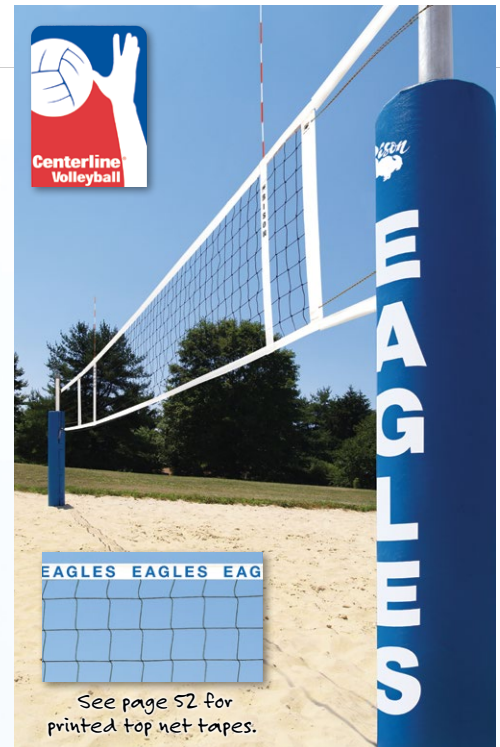

See page 52 for printed top net tapes.



SVB27 TwistLock™ Sand Volleyball Sockets

Now you see it...Now you don't • Unique twist lock design allows the socket to be installed

or removed from a permanent concrete base foundation in a matter of seconds • No more water or sand filled sockets or sockets that protrude above the sand • These stainless steel sockets will not rust even if left installed year round • The unique concrete foundation with embedded base plate design has a leveling feature to allow precise post leveling and eliminate installation errors • TwistLock sockets come standard with Centerline Elite single and side-by-side systems but can be ordered separately to use with any other indoor competition volleyball systems for maximum utilization of existing equipment • Fits 4" posts • Order **VB354** adapters for use of SVB27 sockets with 3½" posts or **VB340** adapters for use of SVB27 socket with 3" posts.

SVB73 Sand Volleyball Official's Platform with Padding

Perfect for sand courts...Same great features as our indoor Clamp-On Officials Platform but with special sand skids instead of wheels to avoid sinking into the sand • Not compatible with SVB5000 Sand Volleyball Systems • Includes gray padding system conforming to all NCAA, National High School Federation and USVBA rules • Substitute padding in black, maroon, navy, royal or scarlet • Five-year limited warranty on stand.



SVB28 Premium Sand Boundary Kit

Kit comes complete with ½" yellow rope spliced into a continuous loop to mark the outer boundary of an official



sand volleyball court...Includes galvanized ground anchors that screw below the playing surface for maximum player safety • Two-year limited warranty.

SVB26 Boundary Kit

Mark your sand volleyball court boundaries...Kit includes 2" wide black web boundary lines, sand anchors and ground stakes • Adjustable for any size court.



24" Diameter x 30" Deep Concrete Footing



800-247-7668



www.bisoninc.com

57



SVB5000 Shown with Optional ABC52 Lettering

SVB5000A Match Point™ Competition Outdoor Volleyball System

Sand volleyball can now be played at the same level as on the hardwood court...Rugged system designed for California-style power volleyball • Extruded Aluminum 3½" posts are powder coated silver/gray • Net is infinitely adjustable to insure exact net height for competition or recreational volleyball • Tightens with the same mechanism found on our Match Point indoor competition systems • **Includes post padding, net and antennas** • Optional padding lettering or logo available for team or sponsor recognition (see back of catalog for color options) • Install permanently in concrete or use optional **SVB210** ground sleeves • Five-year limited warranty.



Strap Style Worm Gear Winch

SVB5050A Outdoor Volleyball System

Same system as SVB5000A except without antennas and padding...Five-year limited warranty.

SVB500A Court Adder for SVB5000A or SVB5050A

Designed for adding additional courts with a single post... Includes post, net tensioning and adjustment mechanism • Nets and other components sold separately • One SVB500A adds one side-by-side court, order multiple SVB500A to add more courts • Five-year limited warranty.



SVB210 Ground Sleeve (not shown)

For removable installation of SVB5000A, SVB5050A or SVB500A...This steel sleeve, buried in concrete, allows for easy removal of posts when not in use • When installed according to instructions, the top of the sleeve is approximately 6" below the top of the sand, so sand can be safely used for other activities • Durable molded plastic cap keeps sand out • Each post requires one sleeve.



SVB2000A

SVB2000A Aluminum Recreational Volleyball System

The perfect volleyball system for playing in the sand or grass whenever the goal is fun...

Recreational leagues, beach resorts, campgrounds, playgrounds, parks, school yards, any place where a group gathers to play volleyball • 3½" diameter aluminum extruded posts permanently install in a 30" deep x 8" diameter concrete footings or can be installed using VB21 ground sleeves (optional) to allow easy removal of the poles when not in use • Rigid, lightweight aluminum is 100% rust-proof • Net is infinitely adjustable from men's competition volleyball height, 7' 11⁵/₈", to as low as 42" tennis height • Poles are capped to keep out moisture • Crankless net tightening • Powder coated finish • Includes net with fluorescent top tape and all necessary hardware • Two-year limited warranty on standards.



SVB08 Recreational Volleyball Net Official size 32' x 36" nylon net with

fluorescent top tape for maximum visibility...Nylon top rope • Black webbing • Fits SVB2000A and most net games • Weather-resistant • Net color subject to change • 90-day limited warranty.



VB21 3½" Round Ground Sleeve

These aluminum ground sleeves allow removal of your SVB2000A aluminum volleyball system...Sleeves mount permanently in a 30" deep x 10" diameter hole filled with concrete • Cap keeps out rain, snow and dirt • SVB2000A requires two sleeves, each sold individually.



TB300 Indoor/Outdoor Portable Tetherball Set

Play anywhere......1 3/4" diameter, 10' galvanized steel one-piece pole mounted to 24" diameter steel base with 130# of built in ballast for stability • Easy roll wheels
 • Includes ball, rope and top ring • Non-marking rubber ring on bottom of base
 • Quick set up with no hole to dig or loose weight bags to carry • One-year limited warranty on pole and base.

TB200 Premium In-Ground Tetherball Set

Super heavy duty......2 3/8" one-piece galvanized pole • TB50-B tetherball/rope assembly
 • 2 year pole warranty • Order **TB200GS** for optional ground sleeve for easy pole removal • Requires truck shipment.

TB200P Premium In-Ground Tetherball Pole Only

Order ball and ground sleeve separately.

TB100 In-Ground Tetherball Set

Outdoor durable......includes 2 piece 1 7/8" diameter galvanized steel pole
 • TB50-B tetherball/rope assembly • 1 year pole warranty • Order **TB100GS** for optional ground sleeve for easy pole removal • **Ships small package.**

TB100P In-Ground Tetherball Pole Only

Order ball and ground sleeves separately.

Tetherball Ground Sleeves

Rust proof......PVC tube with drop-in aluminum top plug when post is removed
 • Order **TB200GS** for use with TB200 and **TB100GS** for use with TB100.



TB300



TB100

TB50-B Tetherball

Ready to install on pole......Quality official tetherball • Includes 30" long top chain, pole attachment clip and lower rope • rope clips to bottom of chain for easy ball removal.

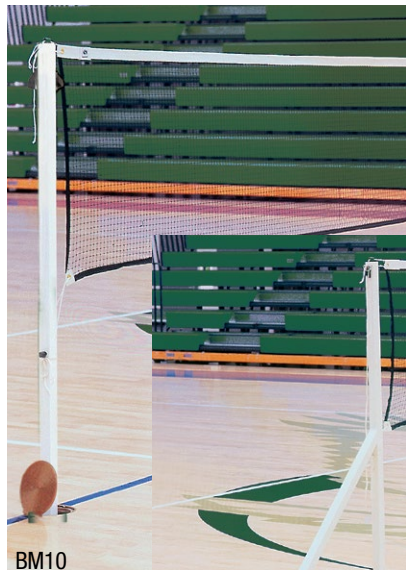

BM10

BM10 Competition Badminton System

For official competition or physical education class......Suits every level of play • 1 11/16" square aluminum standards designed to set up and tear down quickly • System includes official net • Order **BM21** sockets and brass floor plates separately
 • Consult with a Bison product specialist for replacement systems for existing sockets • Two-year limited warranty.

BM100 Badminton Court Adder

Create any number of side-by-side courts with this single post......Order net and floor sockets (if applicable) separately
 • Two-year limited warranty.



BM10P

BM10P Portable Badminton System

Competition play without sockets or floor anchors......Portable yet sturdy • Each end support is designed with a 1 11/16" square post with built-in ballast outrigger and floor friendly transport wheels • Quick and easy set up, tear down and storage • Two-year limited warranty.

BM10N Official Badminton Net

Nylon competition badminton net......Official 20' x 2 1/2' size • Fits any standard badminton system • 90-day warranty.

BM21 Standard Badminton Floor Socket for 1 11/16" Square Badminton Posts (not shown)

Compact hinged brass cover......hides 12" deep socket designed for 1 11/16" square badminton or other game posts • 4 1/2" outside and 3" opening diameter.



BM21
Small Hinged
Brass



Pickleball and Badminton Post Adapters

Use Bison 1 11/16" pickleball or badminton posts in existing volleyball sockets • Specify **BM300A** for 3" sockets, **BM350A** for 3 1/2" sockets or **BM400A** for 4" existing sockets • Aluminum adapters install without tools for quick setup.



BM1016 Badminton Post Cart

Transport and store......up to 16 Bison BM10 competition badminton posts • Floor friendly casters • Can be used for any other badminton post that is smaller than 1 3/4" square or round
 • Compact 22" x 22" footprint • Stores posts upright • One-year warranty.





Modern tennis was first played in Birmingham, England, in approximately 1860 and has grown to worldwide popularity. Tennis can be played on grass, clay or hard surfaced courts. Equipment and rules have changed since the origins of the sport but today's game requires quality equipment regardless of the level of play.



TN10

TN10 Competition Tennis System

Indoors or outdoors...

Competition system for any level
 • 42' net with 49' coated top cable (TN10N) • 3" round, high tensile aluminum posts with durable green powder coated finish • Chrome plated internal winch to tension top cable

- Removable handle • System includes posts, indoor/outdoor official net and center court net hold down strap and anchor
- Order optional **TN23** or **TN235** sockets separately for easy post removal • Consult with a Bison product specialist for replacement systems for existing sockets
- Two-year limited warranty.

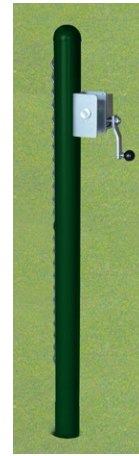

TN05

TN05 Recreational Tennis System

These 3" diameter 3/16" wall steel posts have 1/4" diameter welded steel net side lacing loops and dome net cable guides for durability...Tennis green powder coated finish

- Includes backlash free net cable tensioner, TN10N net and TN10CS center court hold down strap • Use as permanent posts or order optional **TN23** or **TN235** sockets for easy removal
- One-year limited warranty.



TN10P

TN10P Portable Tennis System

Now you can set up a quality tennis court anywhere with an appropriate playing surface...Popular TN10 style 3" diameter aluminum posts with lacing bars, dome net cable guides and backlash free internal winch

- Freestanding post assemblies are connected at the bottom by a three-piece, 42' rigid but lightweight 4" square aluminum tubing spreader • Entire system including posts and spreader bar are easily assembled and disassembled • Breaks down for easy transport and storage into five pieces, longest piece being 15' • System includes TN10 net and TN10CS center net hold down strap • Three-year limited warranty (excluding net).

TN10N Premium Tennis Net

For net replacement on any tennis court...Use indoor or outdoors • Includes center court net hold down straps and all required net attachment ropes • 42' net with 49' coated top cable • Order **TN10NP** for net for portable tennis system • One-year limited warranty.

TN10CS Center Court Hold Down Straps

For net replacement on any tennis court...Replacement center strap assembly • Includes ground anchor.

TN23 Indoor Tennis Floor Socket/Floor Plate

Remove tennis posts with ease...10" deep socket installs into court surface • Hinged brass floor plate covers socket when posts are removed.

TN235 Outdoor Tennis Ground Socket/Ground Plate

Same as above but made for the outdoor court...100% removable aluminum cover.



Pickleball is the fastest growing net game in sports and combines elements of tennis, badminton and ping pong. Played indoors or outdoors on competition or recreational courts. Great game for players of all ages and skills. Played with paddles and a plastic ball as singles or doubles. Bison systems are available for all levels of play, indoors and outdoors, permanent installation, removable installation or portable.

PK10XL Competition Pickleball System

Can be used indoors or outdoors either permanently installed in concrete or installed in floor/ground sockets • 3" round tempered, extruded aluminum posts with a green powder coated finish • Chrome plated internal winch to tension top cables • Removable handle to reduce vandalism or net theft • Meets all IFP and USAPA rules • System includes posts, indoor/outdoor PK10NXL net and TN10CS court net hold down strap and anchor • Order **PK23** or **PK235** sockets separately for easy removable installation • Two-year limited warranty.



PK05XL Recreational Pickleball System

3" diameter, 3/16" wall steel standards have 1/4" diameter welded steel net side lacing bar and dome net cable guides • Meets all IFP and USAPA rules • Includes backlash free net cable tensioner, PK10NXL net and TN10CS center court hold down strap • Install for permanent use or order optional **PK23** or **PK235** sockets for easy removable installation • One-year limited warranty.



PK10XL

PK05XL

PK10NXL

PK10NXL Competition Pickleball Net

Official 21'9" x 36" high net with 1 3/4" mesh • 4mm nylon coated top cable • Meets all IFP and USAPA rules • One-year limited warranty.

PK23 Indoor Pickleball Floor Socket/Cover Plate

Remove pickleball posts with ease • 3" diameter x 10" deep socket installs into court surface • Hinged brass floor plate covers socket when posts are removed • Requires two per system.

PK235 Outdoor Pickleball Ground Sockets/Cover Plate

Same as above but designed for outdoor courts • 100% removable aluminum cover • Requires two per system.

PK10 PE Pickleball System

Pickleball has grown in popularity and this system can be installed in sockets indoors or outdoors for recreational use by players of all ages • 1 1/16" square aluminum standards have a white powder coated finish and include easy-to-use crankless net tensioning system, a **PK10N** net and **PK10CS** center net hold down weights • Compatible with **PK21** floor sockets (sold separately) • Can also be used in existing indoor 3", 3 1/2" or 4" volleyball floor sockets for PE use with adapters shown on page 49 • Two-year limited warranty.

PK10P Portable PE Pickleball System

Heavy weighted base with integrated transport wheels makes set up easy and fast in any indoor or outdoor location • System includes 1 1/16" square, white powder coated aluminum uprights, crankless net tensioning system, PK10N net and weighted center net hold downs.



PK10

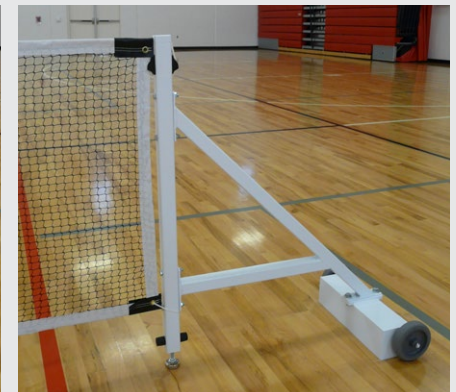

PK10P

PK10N PE Pickleball Net

20' x 2 1/2' high with white top tape • 90 day limited warranty.

PK21 PE Pickleball Floor Sockets

For installation in all types of playing surfaces • Rust free aluminum sockets with hinged brass floor plate • Requires 2 per system.



PK21 Small Hinged Brass



PK10CS Weighted Center Hold Down





Special Features of Bison Portable Aluminum Soccer Goals

Your program is not just like everyone else's. Your level of play, playing surface, goal removal requirements and budget all define your needs. Many programs that use brand name alone as their selection criterion often miss out on features that better fit their requirements. Bison offers a wide range of goals to meet the needs of college, high school, club, recreation and youth programs. Consider the following design features before you invest in your next pair of goals.



Torque Tested Backstay Attachment

Manufactured or Locally Produced Goals

Over 80% of all portable goal tip over injuries and deaths reported in a recent study occurred with the use of homemade goals produced in shop class or at a local fabrication facility. Failure to understand and follow guidelines and testing requirements found in ASTM F2950-14 and ASTM F1938-98 leads to lack of adequate tip over ballast or ground anchoring, unsuitable goal depth and heavy materials and construction that make goals top heavy. Off the shelf tubing commonly has sharp corners that affect safety. It is critical to purchase goals that have proper warning labels that also certify the goal meets the ASTM safety standards to reduce liability risk for your program.

Portability

Since many soccer fields serve double duty, portable goals make up a large percentage of the market. Even if the goal is not permanently attached to the ground, it might not be truly portable. Overall weight, use of rear stabilizing bars, transport systems and the quality of construction all contribute to the true portability. Common problems with hard to move portables include premature failure of welded corners and the potential for staff or player injury. Aluminum is the material of choice for portable goals. There are some lower cost steel portables but they are heavy, hard to move, prone to rust, and worst of all, dangerous if they tip over.

If you have full-time soccer fields, permanent or semi-permanent goals might fit your needs best. Generally, they offer a lower cost alternative with either steel or aluminum as viable options. Bison No-Tip Soccer goals are the perfect balance between portability, durability and safety.

Football Gooseneck Post Compatibility

Many high schools and collegiate soccer programs share facilities with football and other activities. It is vital that portable soccer goals are compatible with permanently installed football goalposts, allowing quick and easy conversion from football to soccer and back. Most official size (24' x 8') Bison Shootout portable goals, **excluding those with the No-Tip feature**, allow placement in front of permanent football goal posts using the same goal line for both sports by moving the rear horizontal stabilizer bar forward or backward. This is especially critical for fields with permanently painted field markings.

Post Size Compatibility

NCAA, National High School Federation and FIFA rules require that front uprights and crossbars be no less than 4" and no more than 5" wide for official play. Round, square, rectangular or oval shaped materials are all permitted. Round goals are often selected by clubs that play by FIFA rules but many other programs like round as well. If you choose square or rectangular goals, pay attention to the corners on the tubes. The bigger the radius, the greater the player safety. Bison offers round or square goals with large corner radii.

Goal Size

Official play at high school, college and many club levels requires 24' wide and 8' high goals. These are the goal opening dimensions. Youth goals are available in a variety of sizes and often local club rules, field availability or other factors will determine goal width. Generally, younger players use smaller fields and goals.

Competition 24' x 8':	U12 and up, high school, collegiate, international
Club Plus 21' x 7':	U10 - U12
Club 18½' x 6½':	U8 - U10
Youth 12' x 6½':	U6 - U8 and short-sided play
Bantam 9' x 4½':	U4 - U6 and short-sided play

Post Safety

Over the past few years, there has been an increasing awareness of soccer player injury statistics. While most injuries occur in the open field, injuries including concussions, broken bones, cuts and damaged teeth caused by player contact with goals are common.



If you prefer square or rectangular goals, look for manufacturers who use a large corner radius on all upright and crossbar tubes. Choose portable goals with the greatest back depth (10' on 24' x 8' goals) and provide premium anchoring or built-in ballast systems as a part of the package. Soccer is currently the most played team sport that does not require padding on equipment that players might come in contact with during competition. In the last few years, however, there has been a steady move in the direction of allowing and using upright padding to protect players and reduce program liability. All play that is governed by National High School Federation rules now allows post padding. Only Bison manufactures goals that can maintain the official 24' width with or without upright padding. Bison DuraSkin for Soccer padding has virtually no negative impact on ball rebound. To assure safety and avoid unnecessary liability, NEVER purchase goals that do not meet ASTM F2950-14 safety standards.

Convenience

It's always easiest to buy in complete, ready-to-play packages. This insures all components are compatible. Features like transport systems and built-in safety ballast on portable goals make goal movement easier and safer. Net attachment methods are not all the same. Avoid systems that have loose clips or hook and loop straps that get lost and goals with protruding net attachment hardware that presents a safety issue. Most programs prefer goals with built-in net attachment tracks like Bison's QwikTrack.

Durability/Warranty

When you invest in soccer goals, you want to be confident they will provide maintenance free service for many years. Aluminum goals have the advantage of a lifetime of rust free use. Some common aluminum goals, however, are prone to failure of welds where backstays attach to uprights. Big bulky goals get dragged across the field, putting stress on joints and resulting in the need for costly repairs. Bison's unique Torque Tested backstay attachment system, standard rear stabilizer bar and the inclusion of built-in transport and ballast systems on many goals allow Bison to offer an industry leading, **eight-year limited warranty** on 4" round and 4" square No-Tip goals. Compare standard features and published warranties to get the most value for your investment.

Purchasing through a local dealer is not only friendly to your local economy but improves your service when you need help.



No-Tip Transport/Ballast System On Many Styles



QwikTrack™ Easy and Dependable Net Attachment



Football Field Compatibility



Large Corner Safety Radius on Square Post Options





NEW!
BISON IS THE EXCLUSIVE SOCCER GOAL PARTNER OF THE NFHS

No-Tip™ Portable Aluminum Soccer Goals

No Loose Ballast No Ground Anchors



As the name implies, Bison No-Tip goals eliminate the need for dependable and inconvenient ground anchors, ballast bags or other goal tip over safety options that rely on human behavior to insure safety. Once properly filled with sand and installed, these No-Tip drums not only eliminate the threat of forward tipping onto players hanging on the goal crossbar but also allows easy transport on and off the field and the reduction in the stress on vulnerable welded goal joints that can cause premature goal deterioration. The combination of our No-Tip transport system and our torque tested backstay attachments system allow us to offer an industry leading **eight-year limited warranty** on all No-Tip goals.

Additional standard No-Tip goal features include extra deep goal depth, competition net, QwikTrack net attachment system, net storage bag and a super thick textured white powder coated finish. See chart below for aluminum opening extrusion shapes and overall goal size options.



NO-TIP MATCH STATS	
Portable	Yes
Goal Opening Material	Aluminum extrusions
Extrusion Size/Shape	4" round or 4" square
Number of Goal Sizes	3
Extra Rear Depth	Standard
No-Tip Ballast/Transport System	Standard
Competition Net	Included
Net Storage Bag	Included
QwikTrack Net Attachment System	Standard
Side Post Safety Padding	Optional
Meets ASTM F2950-14/ F1938-98	Yes
Meets NCAA, NF and FIFA Standards	Yes
Powder Coated Finish	Yes
Warranty	Eight-year limited



No-Tip Transport/Ballast System
Now With Net Retention Bar

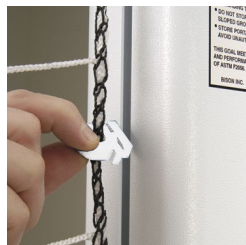

QwikTrack™
Net Attachment Included



Competition Net Included



Net Storage Bag Included



Optional Player Safety
Padding (see page 68)

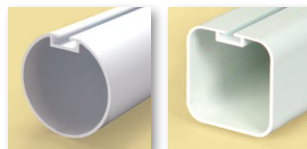

No-Tip™ Soccer Package Chart

	Age Range	Width	Height	Top Depth	Bottom Depth	4" Round Model #	4" Square Model #
Official Competition	U12+	24'	8'	4"	10'	SC2480PA40NT	SC2480PA44NT
Club Plus	U10-U12	21'	7'	4"	7'	SC2170PA40NT	SC2170PA44NT
Club	U8-U10	18½'	6½'	4"	6½'	SC1865PA40NT	SC1865PA44NT

**MEETS
 ASTM F2950-14 and
 ASTM F1938-98**



800-247-7668



www.bisoninc.com

5-YEAR
Limited Warranty



NEW!

BISON IS THE EXCLUSIVE SOCCER GOAL PARTNER OF THE NFHS



SC2480PA44E Shown with Optional SC44PP Safety Padding

ShootOut™ Portable Aluminum Soccer Goals

All Bison ShootOut soccer goals are constructed with special aluminum extrusions in either 4" round or 4" square with rounded safety corners and our exclusive torque tested backstay attachment system reducing the stress on vulnerable joints that often result in premature goal weld failure. Available in three sizes. All ShootOut soccer goals feature extra rear depth for reduced tip over risk and a rear horizontal stabilizer bar that can be positioned closer to the goal face for compatibility with football goal posts on shared sport fields. Nets attach easily with our QwikTrack net clip system.

Additional standard features include ground anchor kit, competition net and super thick textured white powder coated finish, optional features include vertical post padding and ballast bags for use on artificial turf. ShootOut goals carry a five-year limited warranty. See chart below for aluminum opening extrusion and overall goal size selection. Wheel kit options available on page 68.

**MEETS
ASTM F2950-14 and
ASTM F1938-98**

SHOOTOUT MATCH STATS	
Portable	Yes
Goal Opening Material	Aluminum extrusions
Extrusion Size/Shape	4" round or 4" square
Number of Goal Sizes	3
Extra Rear Depth	Standard
No-Tip Ballast/Transport System	Optional
Rear Ground Anchors	Included
Rear Ballast Bags	Optional
Competition Net	Included
Net Storage Bag	Included
QwikTrack Net Attachment System	Standard
Side Post Safety Padding	Optional
Meets ASTM F2950-14/ F1938-98	Yes
Meets NCAA, NF and FIFA Standards	Yes
Powder Coated Finish	Yes
Warranty	Five-year limited



THREE POPULAR SIZES



Qwik Track™ Net Attachment Included



Ground Anchor Kit Included



Optional No-Tip Transport/Ballast System Now With Net Retention Bar (see page 68)



Competition Net and Storage Bag Included



Football Field Compatibility (with SC106N net)



Optional Player Safety Padding (see page 68)

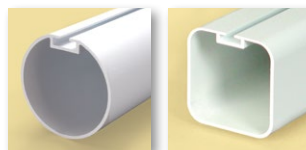

ShootOut™ Soccer Package Chart

	Age Range	Width	Height	Top Depth	Bottom Depth	4" Round Model #	4" Square Model #
Official Competition	U12+	24'	8'	4'	10'	SC2480PA40E	SC2480PA44E
Club Plus	U10-U12	21'	7'	4'	7'	SC2170PA40E	SC2170PA44E
Club	U8-U10	18½'	6½'	4'	6½'	SC1865PA40E	SC1865PA44E





NEW!
BISON IS THE EXCLUSIVE SOCCER GOAL PARTNER OF THE NFHS
 PARTNER

Tourney 3" Portable Aluminum Soccer Goals

Need goals...but have a limited budget? These 3" diameter extruded aluminum soccer goals have many of the premium features found on our 4" ShootOut goals but the reduced extrusion size and design features allow you to purchase more goals for the same money • Available in 5 sizes, all 3" goals include QwikTrack Net Attachment System, rear stabilizer bar and extra rear depth for superior tip over safety, white powder coated finish and rear ground anchors • Competition net and net storage bag included • While no manufacturers' 3" soccer goals meet NCAA, NF or FIFA rules, they are ideal for facilities where youth and club soccer is played • Order optional No-Tip ballast system or wheel kit separately • Goals meet **ASTM F2950-14 and ASTM F1938-98** safety standards • Bison 3" Tourney goals carry a three-year limited warranty. • See chart below.



3-YEAR Limited Warranty

MEETS ASTM F2950-14 and ASTM F1938-98

3" TOURNEY MATCH STATS	
Portable	Yes
Goal Opening Material	Aluminum Extrusions
Extrusion Size	3" Round
Number of Goal Sizes	5
Extra Rear Depth	Standard
Rear Ground Anchors	Included
No-Tip Ballast (Transport System)	Optional
Rear Ballast Bags	Optional
Competition Net	Standard
Net Storage Bag	Standard
QwikTrack Net Attachment System	Standard
Side Post Safety Padding	Not Available
Meets ASTM F2950-14/ F1938-98	Yes
Meets NCAA, NF and FIFA Standards	No
Powder Coated Finish	Yes
Warranty	Three-year limited

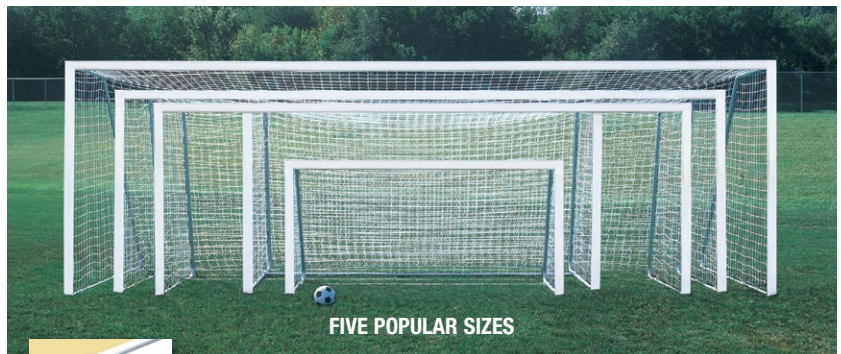

3" Round Extrusions



QwikTrack™ Net Attachment Included



Ground Anchor Kit Included



Optional No-Tip Transport/Ballast System Now With Net Retention Bar (see page 68)



Competition Net and Storage Bag Included



Rear Stabilizer Bar Included



SC50B Ballast Bag

Safety first...Use in place of ground anchors on artificial turf fields or as preferred anchoring method • Requires two per goal • Black vinyl bag with zippered sides • Capacity for 70# of sand or gravel (customer provided).

	Age Range	Width	Height	Top Depth	Bottom Depth	Model #
Official Size	U12+	24'	8'	4'	10'	SC2480PA30E
Club Plus	U10-U12	21'	7'	4'	7'	SC2170PA30E
Club	U8-U12	18½'	6½'	4'	6½'	SC1865PA30E
Youth	U6-U8*	12'	6½'	4'	6½'	SC1265PA30E
Bantam	U4-U6*	9'	4½'	2'	4½'	SC0945PA30E

*Or shortsided



800-247-7668



www.bisoninc.com

ALL ALUMINUM NO-TIP™ PORTABLE SOCCER GOALS

8-YEAR
Limited Warranty



All Aluminum No-Tip™ Portable Soccer Goal

100% Aluminum... And a whole lot more • The latest development in Bison's super strong line of super safe soccer goals • Fully welded aluminum 4" square uprights and 2" square backstay assemblies feature extra welded gusset plates at critical corner connections to make them virtually unbreakable • Bison's QwikTrack™ net attachment system allows easy net attachment to upright, crossbar, bottom sides and rear of goal • Only Bison offers patented No-Tip™ integrated ballast and transport system insuring both safety and easy goal movement without ground anchors or loose ballast • All Aluminum No-Tip goals meet all NCAA, National High School Federation, FIFA, **ASTM F2950-14** and **ASTM F1938-98** rules and specifications • Specially designed extrusions have extra heavy wall thickness and large corner safety radii to guarantee both durability and safety • These Bison soccer goals feature a super thick bright white textured powder coated finish and carry an **eight-year limited warranty** • 12" wide molded polyethylene drums roll easily even in tall, wet or muddy grass and provide permanent safe ballast when properly filled with sand by customer at the time of installation • **Goals include nets, net storage bag, net attachment system and No-Tip system** • Sold in pairs • Eight-year limited warranty.



2" Square QwikTrack™ Side and Rear Rails

4" Square Large Corner Safety Radius

No-Tip Transport/ Ballast System Now With Net Retention Bar

Optional Player Safety Padding (see page 68)

	Age Range	Width	Height	Top Depth	Bottom Depth	Model #
Official Competition	U12+	24'	8'	4'	10'	SC2480PA44XL

MEETS
ASTM F2950-14 and
ASTM F1938-98

EURO™ FUTBOL GOALS

8-YEAR
Limited Warranty



Euro™ Portable Futbol Goal

Euro styling... makes Euro goal a popular choice for soccer purists • Official 24' x 8' competition goal is constructed almost entirely of 4" diameter white aluminum powder coated extrusions with Bison exclusive QwikTrack net attachment system allowing net to be attached to uprights, crossbar and ground components • European style backstays support net at top • Meets or exceeds **ASTM F2950-14** and **ASTM F1938-98** • **Goals include nets, net storage bag, net attachment clips and ground anchor kit** • Sold in pairs • Eight-year limited warranty.

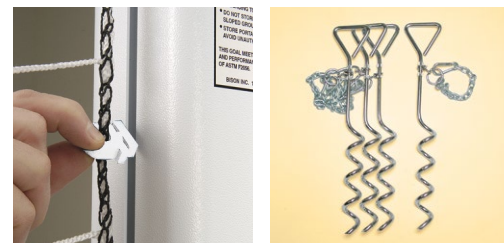

QwikTrack™ Net Attachment Included

Ground Anchor Kit Included

	Age Range	Width	Height	Top Depth	Bottom Depth	Model #
Official Competition	U12+	24'	8'	4'	10'	SC2480PA40EURO

MEETS
ASTM F2950-14 and
ASTM F1938-98



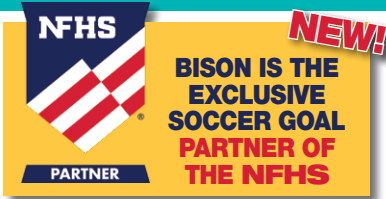

ShootOut™ 4" Square Aluminum Permanent/Semi Permanent Soccer Goals

Just what you would expect from Bison, goals that are durable, affordable and easy to install.

Bison permanent/semi permanent 4" square, powder coated soccer goals are constructed of aluminum extrusions for a lifetime of rustproof service... These goals include Bison's premium QwikTrack net attachment system popular on our aluminum portable goals eliminating loose hook and loop net attachment • Goals can be permanently installed in concrete or be removable with the purchase of **SC44S** ground sleeves

- Available in five sizes • Standard European 4' backstays to add top depth to goals (except SC09451GA Bantam) • **Competition nets and net storage bags included** • Sold in pairs • All in-ground soccer goals have a five-year limited warranty.

Model	Goal Size
SC24801GA	Competition 24'(w) x 8'(h)
SC21701GA	Club Plus 21'(w) x 7'(h)
SC18651GA	Club 18½'(w) x 6½'(h)
SC12651GA	Youth 12'(w) x 6½'(h)
SC09451GA	Bantam 9'(w) x 4½'(h)



SC24801GA



FIVE POPULAR SIZES

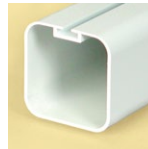

4" Square Large Corner Safety Radius



European Style Backstays Included



QwikTrack™ Easy and Dependable Net Attachment

ShootOut™ Combo Aluminum Football/Soccer Goals

When soccer and football teams share space... Combo Goals are the answer • Constructed of weatherproof 4" square aluminum extrusions • Nets attach with popular Bison exclusive QwikTrack system • 4" square upright and crossbar extrusions have large corner radii for superior player safety and have a bright white, textured powder coated finish • Official 24' (w) x 8' (h) soccer goals and official 10' high football crossbar and 10' uprights that can be installed either at 23'4" high school width or 18'6" college width • Order FB10EXT-WT to extend uprights from 10' to 20' height • Choose in-ground permanent/semi permanent or portable (see details below) • Five-year limited warranties • Sold in pairs.

SC24801GAFB Permanent/Semi Permanent Combo Goals

Install goals permanently in concrete footings or install using optional **SC44S** ground sleeves to allow easy removal... Includes European Style backstays, competition nets and net storage bags.

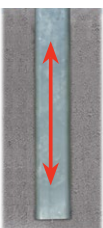

SC44S Ground Sleeves

4" square, 24" deep sockets install in 8" diameter minimum 30" deep concrete footing for easy removal of goals when not in use... Sockets are extruded aluminum and include cap to keep out debris • Order two sleeves per goal (four per field).

SC2480PA44FB Portable Combo Goals

Add the convenience of portability and built-in No-Tip ballast system to the versatility of Combo Goals... Bison No-Tip system insures safety without the inconvenience of ballast bags, ground anchors or other anchor systems that are often forgotten, lost, discarded or ineffective • The rear ballasts double as transport wheels allowing movement on and off the field to improve space utilization. Note: Due to the added weight of the football crossbar and uprights, goal transport typically requires four people • **Includes soccer nets.**



SC24801GAFB



SC2480PA44FB



800-247-7668



www.bisoninc.com



FREE!
Mesh Storage Bag with
Each Pair of Nets



Knotless HTPP Soccer Nets

These premium nets are designed specifically for Bison soccer goals but can be used on any soccer goal with comparable top and bottom depth...Constructed of heavy super high tenacity polypropylene (HTPP) multifilament rachel knotless hexagon netting, these nets are non-abrasive for superior durability and safety • These white mesh nets have heavy rope edges to facilitate proper attachment to goal • Sold in pairs • Each pair of nets comes with a free mesh carry bag for easy transport or storage between games or during the off season • Ninety-day warranty • **Sport nets are not returnable once open.**



Model	Mesh Diameter	Width	Height	Top Depth	Bottom Depth
SC100N	4mm	24'	8'	4'	10'
SC106N	4mm	24'	8'	4'	6'
SC080N	4mm	21'	7'	4'	7'
SC072N	4mm	18.5'	6.5'	4'	6.5'
SC060N	4mm	12'	6.5'	4'	6.5'
SC050N	4mm	9'	4.5'	2'	4.5'
SC045N	4mm	9'	4.5'	0'	4.5'



Soccer Upright Post Padding

Protect your players from injuries caused by contact with goal uprights...Football goal posts, volleyball uprights and basketball backboards are all required to be padded by NCAA and National High School Federation rules • **Isn't it time that soccer players are given the same safety considerations as players of other sports?** • Bison's revolutionary DuraSkin™ molded soccer padding virtually eliminates concerns about the effect of post padding on play • The padding covers the bottom 72" of the posts for improved players safety at all levels of play • Order 2 kits to protect both goals • DuraSkin meets NHSF rules interpretation 1-4-1.

National High School Federation 2004-2005 Soccer Rule Interpretation
Rule 1-4-1: The vertical portion of the goal post may be padded with commercially manufactured material for soccer goals. This material shall be white, have a maximum thickness of 1", be a minimum of 72" high and shall be properly secured. No markings other than a single manufacturer's identification/logo may appear on the goal post padding.

Goal Upright Size	DuraSkin Premium Padding	Shipping Wtg.
4" Square	SC44PP	20#/Kit
4" Round or Elliptical	SC40PP	15#/Kit

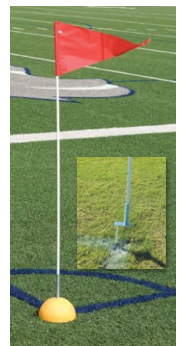

Soccer Corner Flags
Official corner flags in zippered storage bag...Choose SC06CF with ground spikes for natural turf or SC06CFW with sand fillable base for artificial turf or indoor use • Sets of 4.



SC72NC QwikTrack™ Replacement Net Attachment Clips
Compatible with all Bison aluminum soccer, futsal, field hockey and team handball goals...72 clips attaches two nets to two goals.



SC10 Hook and Loop Soccer Net Attachment Kit
Attach any manufacturer's nets to any manufacturer's goals...Double sided hook and loop straps, ground stakes and a storage bag make net attachment easy • Attaches nets to two goals • Kit does not satisfy applicable rules for portable goal tipover safety.



SC04GA Ground Anchor Kit
Auger style anchors are superior to straight ground anchors...Proper use complies with NCAA and NFHS rules regarding anchoring and tip over of portable soccer goals • Set of 4 (two per goal).



SCNOTIP No-Tip™ Retrofit Kit
Retrofit Bison and most other brands and styles of portable soccer goals to improve tip over and transport safety...12" wide molded polyethylene drums each hold approximately 60# of customer supplied sand for ballast and act as rollers for easy transport • Contact Bison for information on compatibility with existing goals • One kit retrofits two goals • Five-year limited warranty.



SC06DK Soccer Skill Practice Disks
8" diameter durable orange plastic • Set of 24.

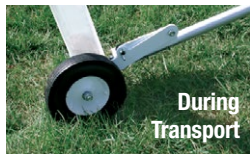

SC04WK Tip and Roll Wheel Retrofit Kit
Add a front transport system to most Bison soccer goals...10" wheels flip forward for use and back for play • One kit retrofits two goals.



SC50B Ballast Bag
Safety first...Use in place of ground anchors on artificial turf fields or as preferred anchoring method • Requires two per goal • Black vinyl bag with zippered sides • Capacity for 70# of sand or gravel (customer provided).





PerfectGoal™ for High School and College

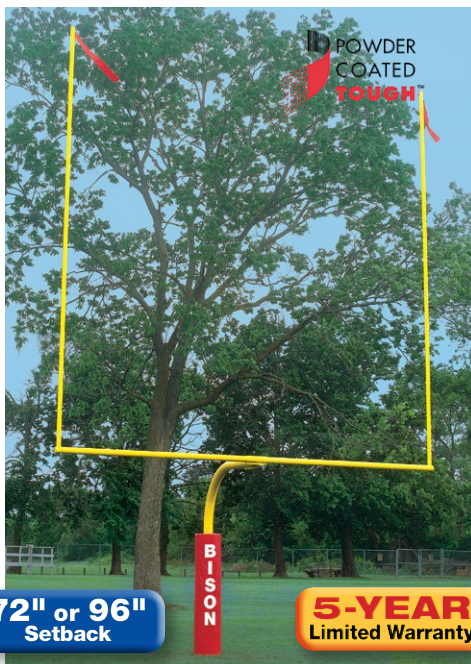

5⁹/₁₆" Gooseneck Goalposts

These are the heaviest Bison goalposts...
 Choose 96" or 72" setback • 48" ground bury
 • 5⁹/₁₆" O.D. schedule 40 pipe is bent then powder coated • All Bison gooseneck goalposts feature Bison's exclusive PerfectGoal design for precise vertical and horizontal alignment and uncommon ease of installation • 4½" steel tube crossbar and 20' long, 2³/₈" diameter aluminum uprights • Order **FB10EXT** to increase upright height from 20' to 30' • Use with **FB55S** ground sleeves if desired • Sold in pairs but available individually • Five-year limited warranty.

Model and Description	Setback
FB55HS-SY High School 5 ⁹ / ₁₆ " Safety Yellow	72"
FB55HS-WT High School 5 ⁹ / ₁₆ " White	72"
FB55CG-SY Collegiate 5 ⁹ / ₁₆ " Safety Yellow	72"
FB55CG-WT Collegiate 5 ⁹ / ₁₆ " White	72"
FB58HS-SY High School 5 ⁹ / ₁₆ " Safety Yellow	96"
FB58HS-WT High School 5 ⁹ / ₁₆ " White	96"
FB58CG-SY Collegiate 5 ⁹ / ₁₆ " Safety Yellow	96"
FB58CG-WT Collegiate 5 ⁹ / ₁₆ " White	96"

4½" Gooseneck Goalposts

Popular 4½" gooseneck styling and Bison's exclusive PerfectGoal design makes these goalposts an excellent value... Posts bury 48" into the ground for stability or use **FB45S** ground sleeves for removable installation • Posts have 60" setback and 20' long aluminum uprights
 • Crossbars are 4½" steel tube • Sold in pairs but available individually. • Five-year limited warranty.

Model and Description	Setback
FB45HS-SY High School 4½" Safety Yellow	60"
FB45HS-WT High School 4½" White	60"

Upright Extensions for Football Gooseneck Goalposts

Increase the upright height from 20' to 30' on 5⁹/₁₆" Gooseneck Goalposts or from 10' to 20' on Aluminum Combination Soccer/Football Goals with these 10' extensions... Includes four 10' aluminum upright extenders and adapter hardware • Order one kit per field • Specify white (**FB10EXT-WT**) or safety yellow (**FB10EXT-SY**)
 • Contact your Bison Product Specialist for details.

FB55CG-SY Shown with Optional FBCPP-SC Padding, ABC52 Lettering and FBWDS Streamers



FBCPPG Full Color Graphic Football Goalpost Padding

Virtually any color or design can be created ...with the assistance of our Art Department • 5" thick high density foam covered with weatherproof 14 oz. vinyl digitally printed and clear laminated for extended life • Protects players to a height of 72"
 • Meets all NCAA and National High School Federation rules • Hook and loop closures • Designed to fit all goal posts to 5⁹/₁₆" diameter and 4" square • Sold in eases • Two-year limited warranty.

FBCPP Solid Color Goal Post Padding

Same 5" thick, 72" high vinyl covered padding in your choice of solid colors found on page 79 • See page 79 for lettering options • Sold individually • Two-year limited warranty.

PerfectGoal™ Adjustable Height Ground Sleeves

These sleeves allow the removal of gooseneck style goalposts on multi-purpose fields... The only goalpost sleeve in the industry that allows accurate adjustment of the crossbar height to official 10' • Hot dip galvanized heavy wall steel base • 4" of total crossbar height adjustment • Built-in anti-rotation device
 • Aluminum cover to finish socket both when installed and removed • Requires minimum 30" diameter x 53" deep excavation • Order two per field • Some assembly required • Use only with Bison goalposts • Order **FB55S** for 5⁹/₁₆" goal posts and **FB45S** for 4½" goal posts.

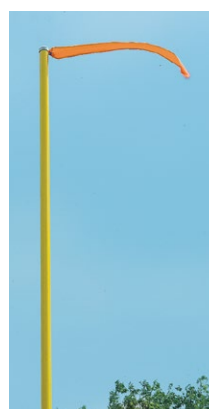
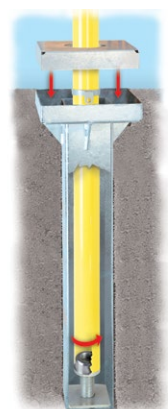

FBWDS Wind Direction Streamers

Official 4" wide x 42" long, weather resistant streamers... Includes hardware to attach to 2³/₈" diameter uprights without drilling
 • Durable orange outdoor flag material, double stitched • Can be used on other size uprights by drilling and bolting • Sold in sets of four.



COMPETITION LACROSSE GOALS

LC200 Official Steel Competition Lacrosse Goals

These goals meet all NCAA and National High School Federation rules for competition play...

- Popular flat iron style base allows use indoors or outdoors on any surface • 1½" (1.9" O.D.) schedule 40 pipe framework has thick ground bars allowing sturdy ground staking or use of ballast bags to stabilize
- Orange powder coated finish
 - Includes four ground anchors
 - 6' (h) x 6' (w) x 7' (d) opening
 - Sold in pairs
 - **Nets and net attachment kit included**
 - One-year limited warranty.

LC050N Official Lacrosse Nets

- Designed to fit Bison lacrosse goals but will fit most official lacrosse goals...6mm white knotless webbing
- Sold in pairs
 - 90-day limited warranty
 - **Sports nets are not returnable once opened.**



LC200

COMPETITION FIELD HOCKEY GOALS

FH200 Outdoor Field Hockey Goals

- Durable design for high level competition...100% rustproof aluminum with premium black weatherproof ¼" UHMW Polyethylene kick boards
- 5 cm (2") square extrusion face
 - White powder coated finish
 - Easy and dependable QwikTrack net attachment
 - Official size meets all USFHA and National High School Federation rules
 - **Nets and net attachment kit included**
 - Two-year limited warranty.

FH200N Field Hockey Nets

- Meets all association rules for official goals... 12' (w) x 7' (h) x 4' (t) x 4' (b) square mesh with heavy braided corners and edges
- Replacement net for FH200
 - Sold in pairs
 - **Sports nets are not returnable once opened**
 - 90-day limited warranty.

FH200WK Wheel Kit for Field Hockey Goals (not shown)

- Transport with ease... Take your goals to and from the field
- 10" diameter wheels mount permanently to the back of field hockey goal frames to increase convenience and reduce risk of player injury or goal damage
 - Some drilling of goal required for installation
 - Includes wheels and hardware for two goals.



5 cm (2" Square) QwikTrack Front Rails



QwikTrack Net Attachment



FH200WK Wheel Kit

SCFUTSAL Official Futsal Goal

A great goal for a great game... 2 meter (approximately 6'7") high and 3 meter (approximately 9'10") wide goal meets official rules • 100% aluminum construction with a durable white powder coated finish • 8 cm square (approximately 3" x 3") aluminum extrusion uprights and crossbars have large corner radii for player safety and Bison's exclusive QwikTrack net mounting system

- Standard rear horizontal stabilizer bar adds durability and stability
- Complete package **includes two goals with rear stabilizer bars, two nets**, QwikTrack net clips, indoor rubber floor protectors and two ballast bags
- Sold in pairs
- Two-year limited warranty.

SC03PP Futsal Safety Padding

Protect futsal players from contact with the corner posts... Vinyl-covered, 1/2" thick padding covers full 79" height of posts • Hook and loop attachment • Sold in kits to protect one goal • Order two kits per court.

SCFUTSALN Futsal and Team Handball Net

Net is designed for Bison futsal goal but can be used on any futsal goal with the same dimensions... 4" octagon mesh constructed of 3mm diameter netting • 3 meter (9' 10") wide and 2 meter (6' 7") high • 80cm (31 1/2") top depth and 100cm (39 3/8") bottom depth • Sold in pairs • 90-day limited warranty • **Sports nets are not returnable once opened.**

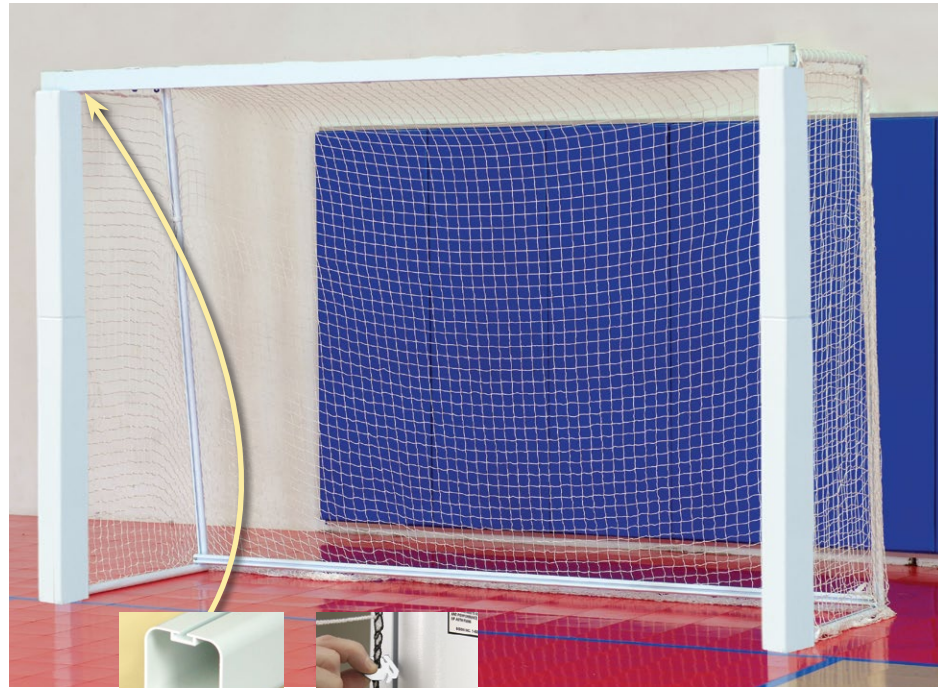

8 cm (3" Square) Tubing



QwikTrack Net Attachment

STFUTSAL Shown with Optional SC03PP Safety Padding

SCTEAMHB Official Team Handball Goal

Goal meets all official handball rules... 2 meter x 3 meter opening • Constructed of 3" square aluminum extrusion tubing • Large safety radii on all corners of tubing corners • Features fast and easy QwikTrack net attachment • Anti-skid floor protectors and portable ballast bags and **net included** • Sold in pairs

- Two-year limited warranty.



SC50B Ballast Bag

Safety first... Black vinyl bag with zippered sides

- Capacity for 70# of sand or gravel (customer provides)
- One ballast bag included with each Bison futsal and team handball goal.

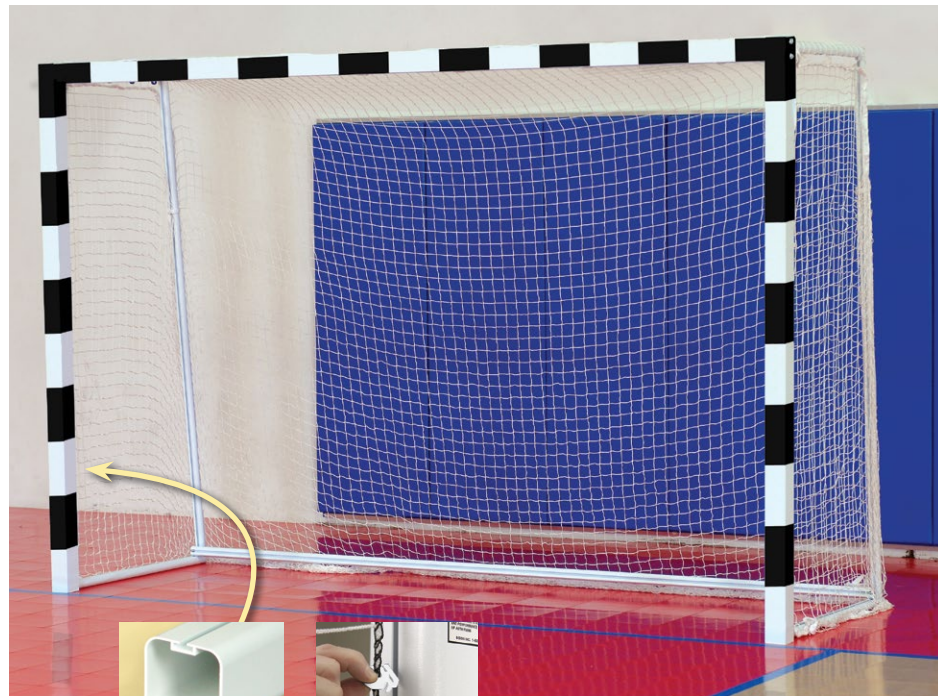

8 cm (3" Square) Tubing



QwikTrack Net Attachment

SCTEAMHB



Easy Store™ Indoor Portable Bleachers



BLI1503AA



Easy Store™ Indoor Bleachers

Portable indoor bleachers provide a mobile solution to seating needs in a wide range of indoor applications and can be used outdoors when desired... When in use, Easy Store bleachers rest on non-marking rubber feet • Just lift front to tilt bleachers onto stable 3" diameter transport casters • Choose from 7½', 15' or 21' lengths in various heights • Heavy-duty 2" x 10" anodized aluminum seat planks • 100% aluminum structure • Planks have end caps for a finished look without sharp edges • High grade zinc plated hardware • See page 74 for information on powder coated seat planks • Five-year limited warranty.

Length	Tiers	Seating Capacity	Approx. Overall Dimension	Model #
7½'	2	10	2' 2" (h) x 3' (d) x 7½' (l)	BLI0702AA
7½'	3	15	2' 6" (h) x 5' 6" (d) x 7½' (l)	BLI0703AA
7½'	4	20	3' 6" (h) x 7' 8" (d) x 7½' (l)	BLI0704AA
15'	2	20	2' 2" (h) x 3' (d) x 15' (l)	BLI1502AA
15'	3	30	2' 6" (h) x 5' 6" (d) x 15' (l)	BLI1503AA
15'	4	40	3' 6" (h) x 7' 8" (d) x 15' (l)	BLI1504AA
21'	2	28	2' 2" (h) x 3' (d) x 21' (l)	BLI2102AA
21'	3	42	2' 6" (h) x 5' 6" (d) x 21' (l)	BLI2103AA

Approximate Indoor/Outdoor Bleacher Dimensions

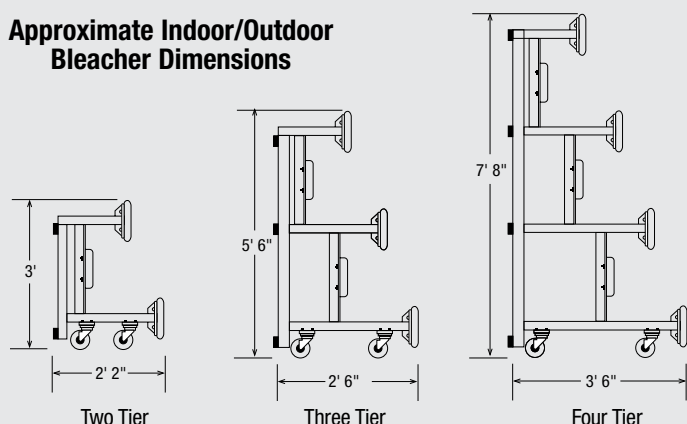

WARNING!

The four tier Bison bleachers shown on this page meet some but not all codes established for bleachers by various agencies. Bison assumes no responsibility for customer selection of bleachers that do not meet local or statewide codes for guard rails, kickboards or other standards.

Weatherbeater™ Outdoor Portable Bleachers



BLO1503AA

BLO1503AA Shown with Optional BL15SEAT-SC Seat Planks



Weatherbeater™ Outdoor Bleachers

These outdoor bleachers are built for a lifetime of dependable, trouble-free sports seating...

Weatherbeater bleachers come with recycled plastic ground runners to keep support framework raised from grass or dirt • Recycled runners will not rot like wood runners used by other manufacturers • Available in 7½', 15' or 21' lengths in either 3 or 4 tier heights • 2 tier bleachers are only available in 15' lengths • Heavy-duty 2" x 10" anodized aluminum seat planks • 100% aluminum structure • Planks have end caps for a finished look without sharp edges • High grade zinc plated hardware • **See page 74 for information on powder coated seat planks** • Five-year limited warranty.



BLO1504AXLAA

WARNING!

The four tier Bison bleachers shown on this page meet some but not all codes established for bleachers by various agencies. Bison assumes no responsibility for customer selection of bleachers that do not meet local or statewide codes for guard rails, kickboards or other standards.

BLO1504AAXL Shown with Optional BL15SEAT-RY Seat Planks



Weatherbeater™ Premium Outdoor Bleachers

An extra measure of comfort and safety... Same basic features as outlined above • The addition of an extra foot rest plank and heel kick panel not only improve safety but also provide comfort, child control and reduced dropped or lost loose objects like jackets, purses and backpacks • **Add color planks (see page 74) to customize your field** • Five-year limited warranty.

Length	Tiers	Seating Capacity	Approx. Overall Dimension	Standard Structure Model #	Premium Structure Model #
7½'	3	15	2' 6" (h) x 5' 6" (d) x 7½' (l)	BLO0703AA	BLO0703AXLAA
7½'	4	20	3' 6" (h) x 7' 8" (d) x 7½' (l)	BLO0704AA	BLO0704AXLAA
15'	2	20	2' 2" (h) x 3' (d) x 15' (l)	BLO1502AA	BLO1502AXLAA
15'	3	30	2' 6" (h) x 5' 6" (d) x 15' (l)	BLO1503AA	BLO1503AXLAA
15'	4	40	3' 6" (h) x 7' 8" (d) x 15' (l)	BLO1504AA	BLO1504AXLAA
21'	3	42	2' 6" (h) x 5' 6" (d) x 21' (l)	BLO2103AA	BLO2103AXLAA
21'	4	56	3' 6" (h) x 7' 8" (d) x 21' (l)	BLO2104AA	BLO2104AXLAA

Approximate Bleacher Dimensions

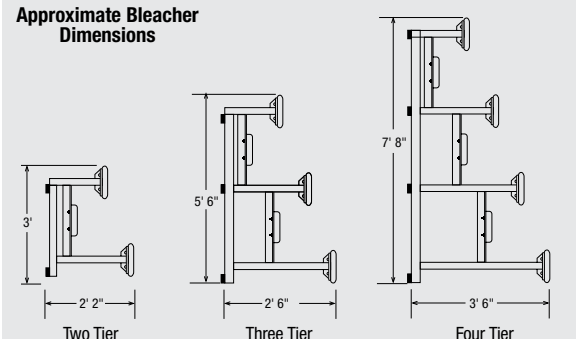

800-247-7668



www.bisoninc.com

73

Player Benches

Benches are available as either in-ground fixed models or wide-base, freestanding portables...Select benches with or without a backrest • 100% aluminum structure • 21' length for fourteen player capacity, 15' for ten players or 7½' for five players • Four 2" square leg supports on 21', three leg supports on 15' and two leg supports on 7½' • 2" x 10" x .08" minimum cross section anodized aluminum seats and backs • Planks have end caps for a finished look without sharp edges • Fixed models require a 30" deep concrete footing to install in-ground for lasting, safe, weatherproof seating • Portable models are constructed to provide a nearly tip-proof bench to transfer from football field to soccer, baseball or softball fields as seasons change • Portable benches can be used with or without rubber feet provided, can be anchored to ground or can be bolted down to courtside surfaces • Five-year limited warranty.



BNP1501BAA

Player Benches with Backrest



BNP1501BAA



BNF1501BAA with optional powder coated backrest



Length	Seating	Fixed or Portable	Backrest	Legs/ Supports	Model #
21'	14	Portable	Yes	4	BNP2101BAA
21'	14	Fixed	Yes	4	BNF2101BAA
15'	10	Portable	Yes	3	BNP1501BAA
15'	10	Fixed	Yes	3	BNF1501BAA
7½'	5	Portable	Yes	2	BNP0701BAA
7½'	5	Fixed	Yes	2	BNF0701BAA

Player Benches without Backrest



BNF0701AA

Length	Seating Capacity	Fixed or Portable	Backrest	Legs/ Supports	Model #
21'	14	Portable	No	4	BNP2101AA
21'	14	Fixed	No	4	BNF2101AA
15'	10	Portable	No	3	BNP1501AA
15'	10	Fixed	No	3	BNF1501AA
7½'	5	Portable	No	2	BNP0701AA
7½'	5	Fixed	No	2	BNF0701AA

Powder Coated Aluminum Planks

Show your school colors on Bison's 7½', 15' and 21' benches or bleachers...

Simply substitute your choice of royal, scarlet, navy, forest green, black or white planks for standard anodized aluminum seats that are included with Bison aluminum player benches, Weatherbeater bleachers and Easy Store bleachers • Choose any combination of colors for any quantity of seat planks • Each powder coated plank will incur an upcharge based on length • Order **BL07SEAT1-XX** for 7½' planks, **BL15SEAT1-XX** for 15' planks and **BL21SEAT1-XX** for 21' planks • **Note minimum charge per color applies** • Orders of 25 or more planks can be powder coated in a wider variety of colors (allow six weeks).



RY-Royal SC-Scarlet NY-Navy



FG-Forest Green BK-Black WT-White



HangTime™ Adjustable Systems

Want playground durability in an adjustable rim height system? Ultimate HangTime provides maximum flexibility for use by players of all ages • The heavy-duty right angle crank can be locked to avoid unauthorized height adjustment with optional **BALOCKHT** HangTime rim height locking device • 6" square heavy wall steel poles and unbreakable clear polycarbonate, tempered glass or steel backboards • All HangTime adjustable systems come standard with outdoor breakaway goal but Bison Ultimate fixed goal (BA39U) may be substituted at no extra cost • Pole system features 56" safe play area and textured black powder coated finish • Other features include New **EZ SwingUp** installation base and easy-to-read height indicator to make installation and rim height adjustment from approximately 7½' to 10' easy • Requires 2 or more adults for installation • See chart below.



Model #	Pole Size	Backboard Size	Backboard Type	Rim	Optional Pole Padding	Optional Backboard Padding	Warranties
PR98UHT	6" Square	42" x 72"	Polycarbonate (Lifetime Warranty on Board)	BA32S Breakaway	BA870PP	BA72U	10-Year Limited on Pole and Rim
PR98GHT	6" Square	42" x 72"	Glass	BA32S Breakaway	BA870PP	BA72U	10-Year Limited
PR98SHT	6" Square	42" x 60"	Steel	BA32 Breakaway	BA870PP	BA60U	10-Year Limited
PR98SXLHT	6" Square	42" x 72"	Steel	BA32 Breakaway	BA870PP	BA72U	10-Year Limited
PR98UHTJR	6" Square	36" x 60"	Polycarbonate (Lifetime Warranty on Board)	BA32 Breakaway	BA870PP	BA60U	10-Year Limited on Pole and Rim
PR98GHTJR	6" Square	36" x 60"	Glass	BA32 Breakaway	BA870PP	BA60U	10-Year Limited

Popular HangTime Features

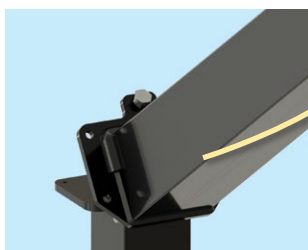

EZ SwingUp Base Installation Position



EZ SwingUp Base Ready For Play



Smooth Operating Right Angle Crank

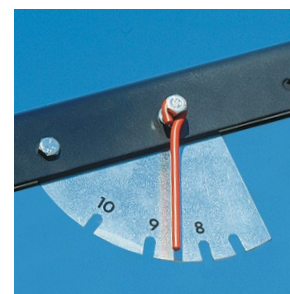

Easy to Read Rim Height Indicator

HangTime™ Redesigned

HangTime installation no longer takes wobbly ladders, heavy lifting, contract installers or 3-4 adults. • Unlike similar systems HangTime **EZ SwingUp** base system allows all assembly to happen safely and easily at ground level • When all assembly is complete, just swing the complete system into vertical position, lock in place with four bolts and you are ready to play.

HTADPT HangTime™ Pedestal Adapter Plate

Use to mount HangTime 6" poles to existing threaded j-bolt style footings with 9" x 9" mounting pattern.



Supplemental Installation Video



Optional Backboard Padding



Optional Crank Lock (BALOCKHT)



800-247-7668



www.bisoninc.com

75

ZipCrank™ Playground Adjustable Systems

The perfect outdoor system for facilities that desire durable adjustable systems at an affordable price • These ZipCrank systems feature clear, unbreakable 3/8" polycarbonate backboards, outdoor breakaway goals, 30" safe play area, removable awning style crank handle and textured black powder coat finish • Choose 4" square or 5" square, 1/8" wall direct bury pole each with an easy-to-read rim height indicator • Rim can be adjusted from 7½' to 10'.

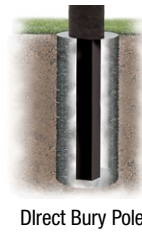

Model #	Pole Size	Backboard Size	Backboard Type	Rim	Optional Pole Padding	Optional Backboard Padding	Warranties
PR95UZC	5" Square	36" x 60"	Polycarbonate	BA32 Breakaway	BA870JRPP	BA60U-BK	Two-Year Limited on Pole and Rim, Limited Lifetime on Backboard
PR94UZC	4" Square	36" x 54"	Polycarbonate	BA32 Breakaway	BA79UPP	BA54U-BK	Two-Year Limited on Pole and Rim, Limited Lifetime on Backboard

QwikChange™ Playground Systems

Popular playground features at a popular price...

Heavy galvanized 3½" steel pole • 36" x 48" molded graphite backboard and flex goal adjusts from 7½' to 10' in 6" increments • QwikChange design requires only a pole to change height from the ground • Choose permanent in-ground or portable system • Great for camps, daycares, church parking lots or anywhere kids of all ages gather to play basketball • One year limited warranty.

BA801 QwikChange™ Portable

Factory installed 350# of ballast...Built-in transport wheels • Order BA801BP and BA700PP for base and pole safety padding.

PR12 QwikChange™ Permanent

36" ground bury...Optional BA700PP pole safety padding.



BA801BP Base Padding

Improve safety with this specially designed pad that covers 360° around the base of the BA801 portable... 1" thick foam with sewn cover in black vinyl • Hook and loop attachment.

Fixed Height Ultimate™ Series

Try the Ultimate on your most demanding outdoor court and you'll never need to buy another basketball system... From the massive 6" square, 3/16" wall pole and extension arm that buries a full 40" into the ground for incredible stability to the tip of the Ultimate goal that carries an unconditional lifetime warranty, these systems are designed to take the abuse common on today's playgrounds • Choose the standard 60" safe play area or upgrade to an extended 72" safe play area on any system by adding model **BA870AXL-BK** • Backboard choices include 42" x 60" or 42" x 72" steel or 42" x 72" perforated steel with white powder coated finish, 42" x 72" clear tempered glass or 42" x 72" clear unbreakable polycarbonate • Systems with steel boards come standard with Bison's Ultimate fixed goal • Glass and polycarbonate systems include outdoor breakaway goals • See page 87 for backboard and pole safety padding options • Double sided options are available on each system to get more play for less money • See chart below for options.

LIFETIME Warranty

Unbreakable Polycarbonate

Perforated Steel



BA873U Shown with Optional BA870PP-BK Pole Padding and BA72U-BK Backboard Padding

BA874-BK Shown with Optional BA870PP-BK Pole Padding

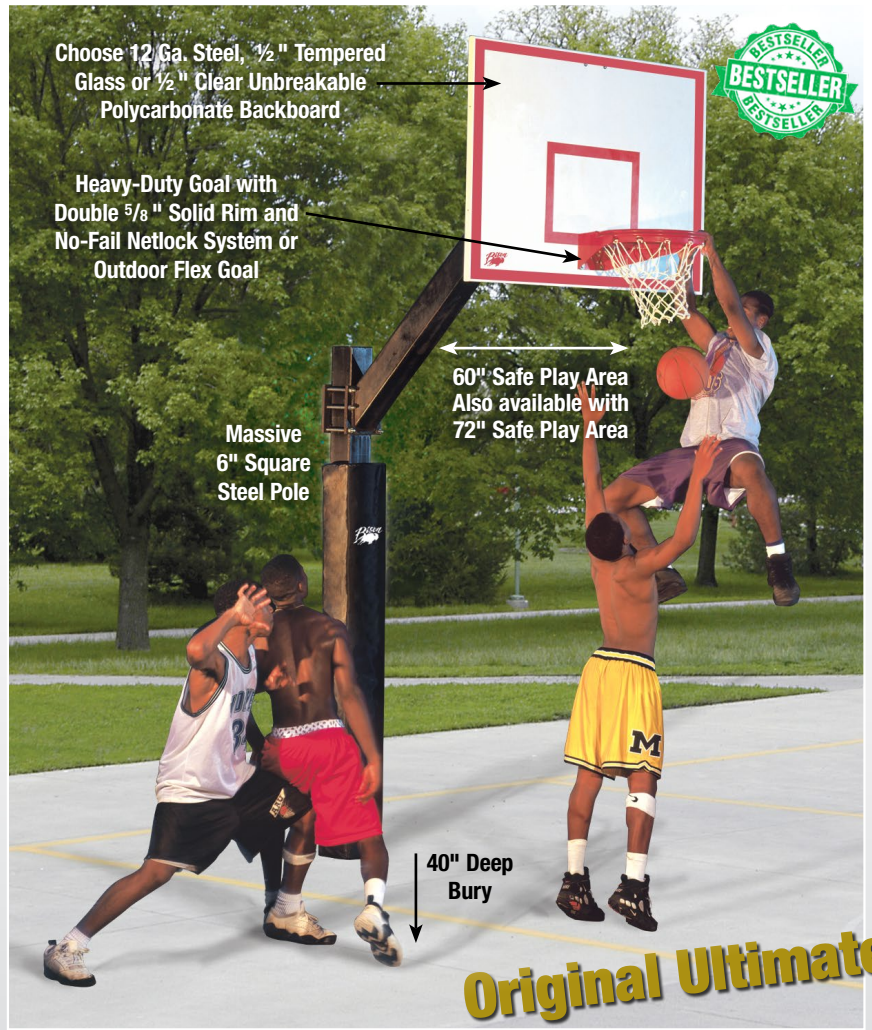

BA871-BK Shown with Optional BA870PP-BK Pole Padding



Any Ultimate playground system can be double-sided. Contact Bison for details.

The Ultimate for durability, playability and value!

See next page for similar features on a downsized system perfect for smaller budgets.

Ultimate Model	Double-Sided Option	Safe Play Area	Backboard Size	Backboard Type	Goals	Pole Finish	Optional Backboard Padding	Warranty
BA871-BK	BA872-BK	60"	42" x 60"	Steel	BA39U Ultimate	Black	BA60U-BK	Lifetime Limited Functional
BA871XL-BK	BA872XL-BK	72"	42" x 72"	Steel	BA39U Ultimate	Black	BA72U-BK	Lifetime Limited Functional
BA874-BK	Available on Request	60"	42" x 72"	Perforated Steel	BA39U Ultimate	Black	BA72U-BK	Lifetime Limited Functional
BA873-BK	Available on Request	60"	42" x 72"	Glass	BA32S Breakaway	Black	BA72U-BK	Pole: Lifetime Limited Functional Goal: 1-Year Limited
BA873U-BK	Available on Request	60"	42" x 72"	Polycarbonate	BA32S Breakaway	Black	BA72U-BK	Pole: Lifetime Limited Functional Goal: 1-Year Limited

Order BA870PP-BK for optional pole padding on single sided systems, BA872PP-BK for optional padding on double sided systems.



800-247-7668



www.bisoninc.com

Ultimate™ Junior Playground Systems

Designed with many of the premium features found on its big brother Ultimate Fixed Systems, but with a smaller price tag and different backboard options. **Ultimate Jr. systems** feature a 5" square, 1/8" wall steel pole that buries a full 36" into the ground. The 4" square extension arm places the face of the backboard approximately 36" from the front surface of the pole and provides a stable and rigid support for one of three different backboard and goal options shown below. Rim is direct mounted through the backboard into the extension arm so eliminates virtually all stress placed on the backboard during aggressive playground play. Backboards are also supported by the extension arm at the top. Order **BA870JRPP** for optional pole padding.

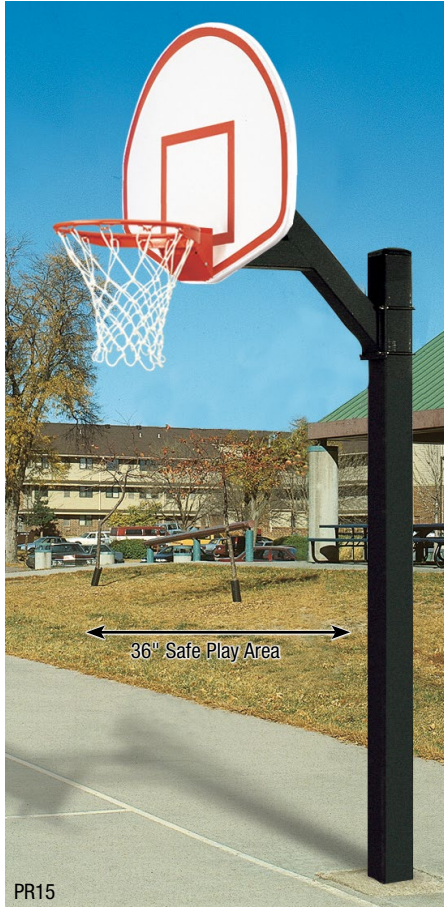

PR15

PR15 Ultimate™ JR Fan Aluminum Playground System

Fan shaped aluminum backboards are the most popular playground backboard in the industry...and will never rust • BA475SS 36" x 54" cast aluminum features heavy rear ribbing, white powder coated finish and orange shooter square and border • Includes Bison BA32 outdoor breakaway goal and premium nylon net. Ten-year limited warranty on system.

PR17 Ultimate™ JR Rectangular Steel Playground System

Same popular 42" x 60" steel backboard as found on our 6" Ultimate system...but at a reduced cost • BA47 backboard is constructed of 12 ga. steel playing surface with all edges safety rolled to eliminate sharp edges and provide extra rigidity • Additional welded rear structure makes this backboard nearly indestructible especially with mounted on Ultimate Jr. direct mount pole • System includes BA32 outdoor breakaway goal and premium nylon net • 10-year warranty on system.



PR17

PR18 Ultimate™ JR Unbreakable Polycarbonate Playground System

Want a backboard that is bullet proof... PR18 is the answer • 36" x 60" clear polycarbonate backboard has heavy aluminum frame and rear support structure to insure that this system will hold up even in the toughest of conditions • Polycarbonate is the material used in bullet proof windows • System includes Bison BA32 outdoor breakaway goal and premium nylon net • Ten-year limited warranty on system.



PR18

Model #	Pole Size	Safe Play Area	Backboard Size	Backboard Type	Optional Backboard Padding	Optional Pole Padding	Goal
PR15	5"	36"	36"x 54"	Aluminum Fan	N/A	BA870JRPP	BA32 Breakaway
PR17	5"	36"	42" x 60"	Steel	BA60U-BK	BA870JRPP	BA32 Breakaway
PR18	5"	36"	36" x 60"	Polycarbonate	BA60U-BK	BA870JRPP	BA32 Breakaway

All packages on this page have a 72" or 96" safe play area, 48" ground bury and lifetime limited pole warranty.

BA780 Mega-Duty 59/16" Gooseneck Pole

Superior rigidity, superior durability and greater safe play area make this pole a must where play is rough... 59/16" O.D., hot dip galvanized steel pipe • 72" or 96" safe play area • Goal mounts directly through backboard to pole to virtually eliminate stress on backboard when hanging occurs
 • Heavy-duty 1⁵/₈" backboard braces • 48" in-ground bury • Add optional **FBCPP** pole padding for increased player safety • Order pole and components separately or in complete packages described below
 • Lifetime limited warranty on pole.

PR74 package includes...BA780 Mega-Duty 59/16" O.D., hot dip galvanized steel pipe with 72" safe play area, heavy 1⁵/₈" support braces, 48" in-ground bury pole (Lifetime limited warranty); BA42UC official 42" x 72" backboard made of clear, bulletproof polycarbonate with heavy extruded aluminum framework, official white shooter's square and border (Lifetime limited warranty); and BA32 outdoor flex goal designed to withstand playground abuse (1-year limited warranty).

PR75 package includes...BA780 Mega-Duty 59/16" O.D., hot dip galvanized steel pipe with 72" safe play area (or order **PR75XL** for 96" safe play area), heavy 1⁵/₈" support braces, 48" in-ground bury pole (Lifetime limited warranty); BA47SSS fan-shaped 35¹/₂" x 54" durable, rust-free aluminum backboard with heavy support ribs, white powder coated finish and orange shooter's square and border (Lifetime limited warranty); and BA39U Ultimate playground goal with double 5/8" steel rim and No-Fail netlock system to add strength and eliminate netlock breakage plus 3/16" thick steel box-style backplate and rim supports, accepts nylon or optional chain nets (Unconditional lifetime replacement warranty).

PR76 package includes...BA780 Mega-Duty 59/16" O.D., hot dip galvanized steel pipe with 72" safe play area, heavy 1⁵/₈" support braces, 48" in-ground bury pole (Lifetime limited warranty); BA495 fan-shaped 39" x 54" backboard with heavy-duty mounting support structure, 12 ga. steel skin, and white powder coated finish (10-year limited warranty); and BA39U Ultimate playground goal with double 5/8" steel rim and No-Fail netlock system to add strength and eliminate netlock breakage plus 3/16" thick steel box-style backplate and rim supports, accepts nylon or optional chain nets (Unconditional lifetime replacement warranty).

PR77 package includes...BA780 Mega-Duty 59/16" O.D., hot dip galvanized steel pipe with 72" safe play area (or order **PR77XL** for 96" safe play area), heavy 1⁵/₈" support braces, 48" in-ground bury pole (Lifetime limited warranty); BA47 Ultimate rectangular 42" x 60" playground backboard made of heavy-duty 12 ga. steel skin with safety rolled edges and white powder coated finish (Lifetime limited warranty); and BA39U Ultimate playground goal with double 5/8" steel rim and No-Fail netlock system to add strength and eliminate netlock breakage plus 3/16" thick steel box-style backplate and rim supports, accepts nylon or optional chain nets (Unconditional lifetime replacement warranty).

PR78 package includes...BA780 Mega-Duty 59/16" O.D., hot dip galvanized steel pipe with 72" safe play area, heavy 1⁵/₈" support braces, 48" in-ground bury pole (Lifetime limited warranty); BA407U rectangular 42" x 54" backboard made of unbreakable bulletproof clear polycarbonate and extruded aluminum framework with white shooter's square and border (Lifetime limited warranty); and BA32 outdoor flex goal designed to withstand playground abuse (1-year limited warranty).

PR79 package includes...BA780 Mega-Duty 59/16" O.D., hot dip galvanized steel pipe with 72" safe play area (or order **PR79XL** for 96" safe play area), heavy 1⁵/₈" support braces, 48" in-ground bury pole (Lifetime limited warranty); BA472PC official 42" x 72" size backboard made of perforated steel popular on inner city playgrounds, 12 ga. steel skin with heavy steel rear framework with safety rolled edges and white powder coated finish (10-year limited warranty); and BA39U Ultimate playground goal with double 5/8" steel rim and No-Fail netlock system to add strength and eliminate netlock breakage plus 3/16" thick steel box-style backplate and rim supports, accepts nylon or optional chain nets (Unconditional lifetime replacement warranty).

PR87 (not shown) package includes...BA780 Mega-Duty 59/16" O.D., hot dip galvanized steel pipe with 72" safe play area (or order **PR87XL** for 96" safe play area), heavy 1⁵/₈" support braces, 48" in-ground bury pole (Lifetime limited warranty); BA472 rectangular official size 42" x 72" backboard made of heavy-duty 12 ga. steel skin with safety rolled edges and white powder coated finish (Lifetime limited warranty); and BA39U Ultimate playground goal with double 5/8" steel rim and No-Fail netlock system to add strength and eliminate netlock breakage plus 3/16" thick steel box-style backplate and rim supports, accepts nylon or optional chain nets (Unconditional lifetime replacement warranty).



PR77
Shown with
Optional BA700PP
Pole Padding

72" Safe Play Area or
Optional 96" Safe Play Area



PR76

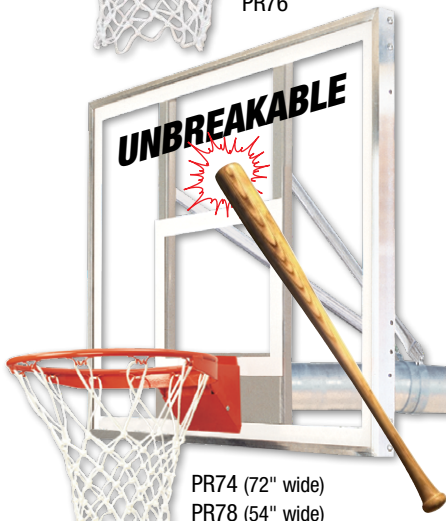

PR74 (72" wide)
PR78 (54" wide)



PR75

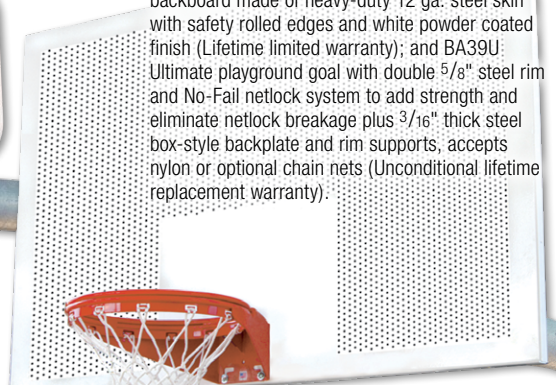

PR79



800-247-7668



www.bisoninc.com

4½" HEAVY-DUTY PLAYGROUND BASKETBALL SYSTEMS

All packages on this page have a 48" or 60" safe play area, 48" ground bury and 25-year pole warranty.

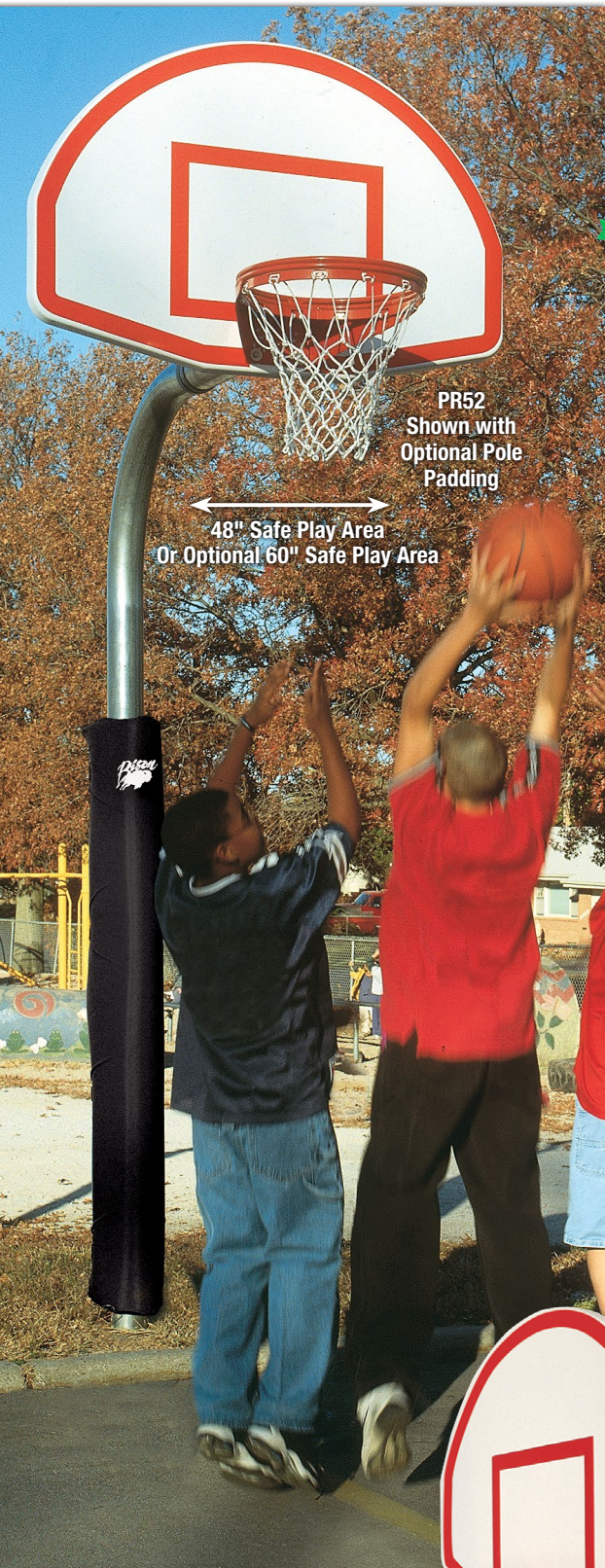

PR52
Shown with
Optional Pole
Padding

48" Safe Play Area
Or Optional 60" Safe Play Area

BA777 Heavy-Duty 4½" Gooseneck Pole

This 4½" O.D. pole provides 48" or 60" safe play area...Direct goal mount design improves backboard durability • Includes heavy-duty 1½" backboard support braces • 48" ground bury for stability even in deep frost regions • Galvanized pole and zinc plated hardware • 5" x 5" goal mounting pattern • 25-year limited warranty • Add optional **BA700PP** pole padding for increased player safety • Order pole and components separately or in popular packages described below • 25-year limited warranty on pole.



PR52 package includes...BA777 Heavy-Duty 4½" O.D., hot dip galvanized steel pipe with 48" safe play area (or order **PR52XL** for 60" safe play area), heavy 1½" support braces, 48" in-ground bury pole (25-year limited warranty); BA475SS fan-shaped 35½" x 54" durable, rust-free aluminum backboard with heavy support ribs, white powder coated finish and orange shooter's square and border (Lifetime limited warranty); and BA39U Ultimate playground goal with double 5/8" steel rim and No-Fail netlock system to add strength and eliminate netlock breakage plus 3/16" thick steel box-style backplate and rim supports, accepts nylon or optional chain nets (Unconditional lifetime replacement warranty).

PR55 package includes...BA777 Heavy-Duty 4½" O.D., hot dip galvanized steel pipe with 48" safe play area (or order **PR55XL** for 60" safe play area), heavy 1½" support braces, 48" in-ground bury pole (25-year limited warranty); BA495 fan-shaped 39" x 54" backboard with heavy-duty mounting support structure, 12 ga. steel skin, and white powder coated finish (10-year limited warranty); and BA39U Ultimate playground goal with double 5/8" steel rim and No-Fail netlock system to add strength and eliminate netlock breakage plus 3/16" thick steel box-style backplate and rim supports, accepts nylon or optional chain nets (Unconditional lifetime replacement warranty).

PR60 package includes...BA777 Heavy-Duty 4½" O.D., hot dip galvanized steel pipe with 48" safe play area (or order **PR60XL** for 60" safe play area), heavy 1-5/8" support braces, 48" in-ground bury pole (25-year limited warranty); BA47 Ultimate rectangular 42" x 60" playground backboard made of heavy-duty 12 ga. steel skin with safety rolled edges and white powder coated finish (Lifetime limited warranty); and BA39U Ultimate playground goal with double 5/8" steel rim and No-Fail netlock system to add strength and eliminate netlock breakage plus 3/16" thick steel box-style backplate and rim supports, accepts nylon or optional chain nets (Unconditional lifetime replacement warranty).

PR70 package includes...BA777 Heavy-Duty 4½" O.D., hot dip galvanized steel pipe with 48" safe play area (or order **PR70XL** for 60" safe play area), heavy 1½" support braces, 48" in-ground bury pole (25-year limited warranty); BA407U rectangular 42" x 54" backboard made of unbreakable bulletproof clear polycarbonate and extruded aluminum framework with white shooter's square and border (Lifetime limited warranty); and BA32 outdoor flex goal designed to withstand playground abuse (1-year limited warranty).

PR70G package includes...BA777 Heavy-Duty 4½" O.D., hot dip galvanized steel pipe with 48" safe play area, heavy 1½" support braces, 48" in-ground bury pole (25-year limited warranty); BA407G rectangular 42" x 54" backboard made of 3/8" thick tempered glass with an extruded aluminum framework and white shooter's square and border (5-year limited outdoor warranty); and BA32 outdoor flex goal designed to withstand playground abuse (1-year limited warranty).



PR70
PR70G



PR55



PR60



All packages on this page have a 36" safe play area, 36" ground bury and 10-year pole warranty.

BA775 Tough-Duty 3½" Gooseneck Pole

Galvanized 3½" O.D. pole comes with zinc plated hardware... Provides 36" safe play area
 • 36" ground bury • Direct goal mount design • Heavy-duty 1½/8" diameter braces to support backboard are included • 5" x 5" goal mounting pattern • Add optional **BA700PP** pole padding for increased player safety • Order pole and components separately or in complete packages as described below • 10-year limited warranty on pole.

PR20 package includes... BA775 Tough-Duty 3½" O.D., hot dip galvanized steel pipe with 36" safe play area, heavy 1-5/8" support braces, 36" in-ground bury pole (10-year limited warranty); BA495 fan-shaped 39" x 54" backboard with heavy-duty mounting support structure, 12 ga. steel skin, and white powder coated finish (10-year limited warranty); and BA27 standard 5/8" steel rim goal with ½" braces and continuous netlocks (1-year limited warranty).

PR31 package includes... BA775 Tough-Duty 3½" O.D., hot dip galvanized steel pipe with 36" safe play area, heavy 1½/8" support braces, 36" in-ground bury pole (10-year limited warranty); BA454 rectangular 39" x 54" backboard made of 12 ga. carbon steel with a white powder coated finish and perforated shooter's square (10-year limited warranty); and BA27 standard 5/8" steel rim goal with ½" braces and continuous netlocks (1-year limited warranty).

PR33 package includes... BA775 Tough-Duty 3½" O.D., hot dip galvanized steel pipe with 36" safe play area, heavy 1½/8" support braces, 36" in-ground bury pole (10-year limited warranty); BA475SS fan-shaped 35½" x 54" white rust-free cast aluminum backboard with heavy ribbing for maximum rigidity and orange border with shooter's square (Lifetime limited warranty); removable rim bracket and removal pole and BA27 standard 5/8" steel rim goal with ½" braces and continuous netlocks (1-year limited warranty). For use by adults only.



PR29 package includes... BA775 Tough-Duty 3½" O.D., hot dip galvanized steel pipe with 36" safe play area, heavy 1½/8" support braces, 36" in-ground bury pole (10-year limited warranty); BA475SS fan-shaped 35½" x 54" durable, rust-free aluminum backboard with heavy support ribs, white powder coated finish and orange shooter's square and border (Lifetime limited warranty); and BA27 standard 5/8" steel rim goal with ½" braces and continuous netlocks (1-year limited warranty).



36" Safe Play Area at 10'

PR31
Shown with
Optional BA700PP
Pole Padding

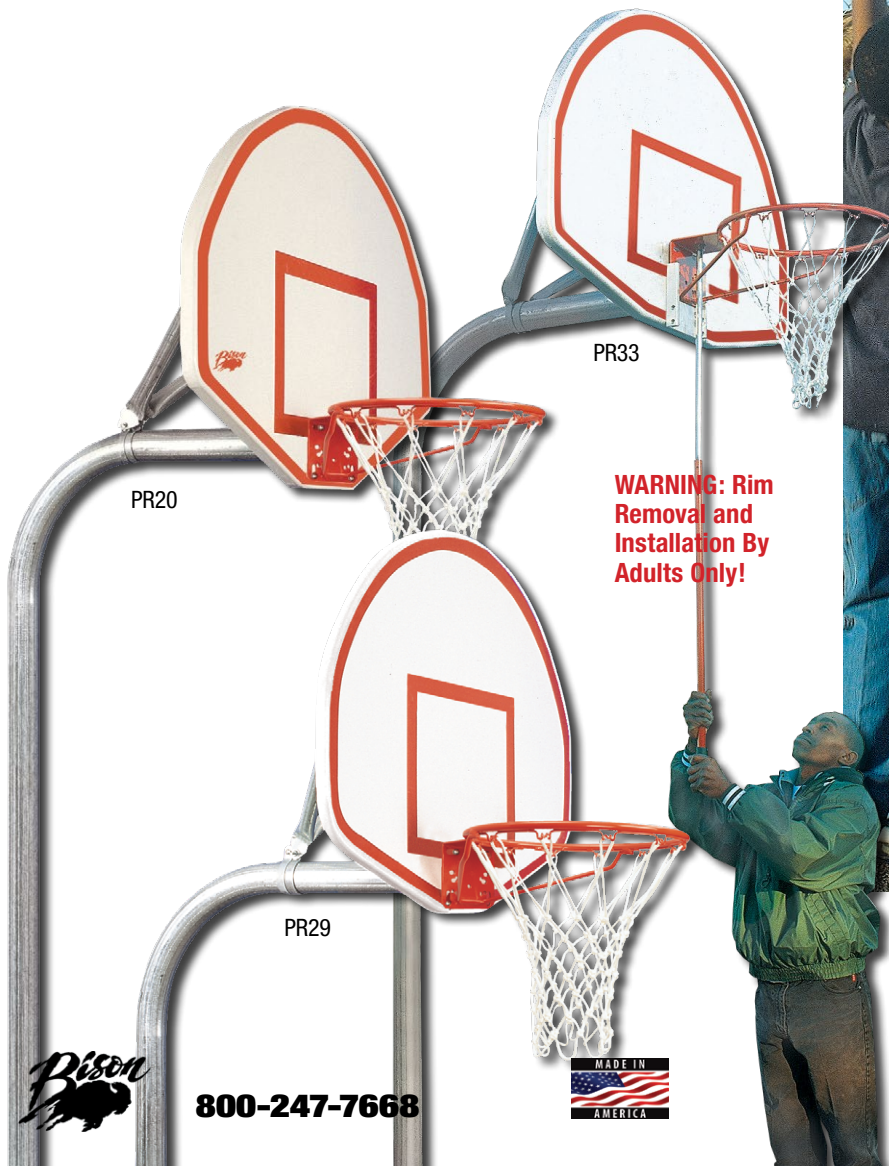

WARNING: Rim Removal and Installation By Adults Only!



800-247-7668



www.bisoninc.com

Playground Basketball Packages

Model #	Adjustable	Safe Play Area	Pole Finish	Backboard Material	Backboard Size/Shape	Goal Style
4" Square Pole See details on page 76.						
PR94UUC	Yes	30"	Black	Polycarbonate	36" x 54" Rect.	Breakaway
5" Square Pole See details on pages 76 and 78.						
PR15	No	36"	Black	Aluminum	39" x 54" Fan	Breakaway
PR17	No	36"	Black	Steel	42" x 60" Rect.	Breakaway
PR18	No	36"	Black	Polycarbonate	36" x 60" Rect.	Breakaway
PR95UUC	Yes	30"	Black	Polycarbonate	36" x 60" Rect.	Breakaway
6" Square Pole See details on pages 75 and 77. <small>*Ask about available 72" Safe Play Area</small>						
BA871-BK	No	60"	Black	Steel	42" x 60" Rect.	Double Rim Fixed
BA871XL-BK	No	72"	Black	Steel	42" x 72" Rect.	Double Rim Fixed
BA873-BK	No	60"	Black	Glass	42" x 72" Rect.	Breakaway
BA873U-BK	No	60"	Black	Polycarbonate	42" x 72" Rect.	Breakaway
PR98UHT	Yes	56"	Black	Polycarbonate	42" x 72" Rect.	Breakaway
PR98GHT	Yes	56"	Black	Glass	42" x 72" Rect.	Breakaway
PR98SHT	Yes	56"	Black	Steel	42" x 60" Rect.	Breakaway
PR98SXLHT	Yes	56"	Black	Steel	42" x 72" Rect.	Breakaway
PR98UHTJR	Yes	56"	Black	Polycarbonate	36" x 60" Rect.	Breakaway
PR98GHTJR	Yes	56"	Black	Glass	36" x 60" Rect.	Breakaway
5⁹/₁₆" Round Single Pole See details on page 79.						
PR74	No	72"	Galvanized	Polycarbonate	42" x 72" Rect.	Breakaway
PR75/PR75XL	No	72"/96"	Galvanized	Aluminum	35½" x 54" Fan	Double Rim Fixed
PR76	No	72"	Galvanized	Steel	39" x 54" Fan	Double Rim Fixed
PR77/PR77XL	No	72"/96"	Galvanized	Steel	42" x 60" Rect.	Double Rim Fixed
PR78	No	72"	Galvanized	Polycarbonate	42" x 54" Rect.	Breakaway
PR79/PR79XL	No	72"/96"	Galvanized	Perforated Steel	42" x 72" Rect.	Double Rim Fixed
PR87/PR87XL	No	72"/96"	Galvanized	Steel	42" x 72" Rect.	Double Rim Fixed
4½" Round Single Pole See details on page 80.						
PR52/PR52XL	No	48"/60"	Galvanized	Aluminum	35½" x 54" Fan	Double Rim Fixed
PR55/PR55XL	No	48"/60"	Galvanized	Steel	39" x 54" Fan	Double Rim Fixed
PR60/PR60XL	No	48"/60"	Galvanized	Steel	42" x 60" Rect.	Double Rim Fixed
PR70/PR70XL	No	48"/60"	Galvanized	Polycarbonate	42" x 54" Rect.	Breakaway
PR70G	No	48"	Galvanized	Glass	42" x 54" Rect.	Breakaway
3½" Round Single Pole See details on pages 76 and 81.						
PR12	Yes	22"	Galvanized	Graphite	36" x 48" Fan	Breakaway
PR20	No	36"	Galvanized	Steel	39" x 54" Fan	Fixed
PR29	No	36"	Galvanized	Aluminum	35½" x 54" Fan	Fixed
PR31	No	36"	Galvanized	Steel	39" x 54" Rect.	Fixed
PR33	No	36"	Galvanized	Aluminum	35½" x 54" Fan	Removable
BA801	Yes	22"	Galvanized	Graphite	36" x 48" Fan	Breakaway



BA39U **Ultimate™** Front Mount Playground Goal

The first and still the **ONLY** unconditional lifetime replacement warranty on a basketball goal!

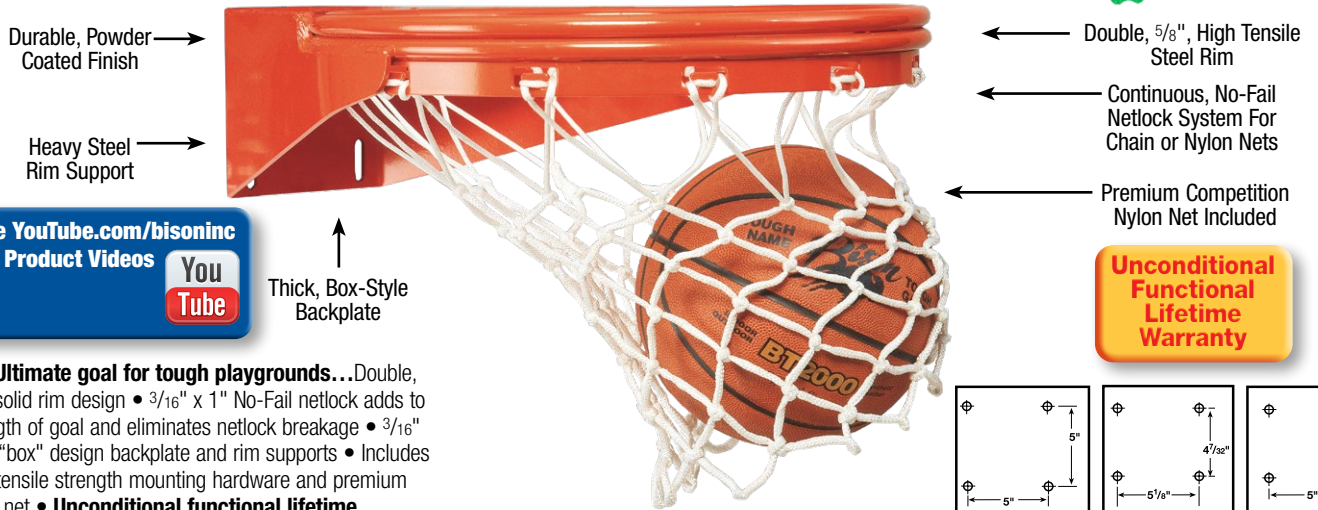

The **Ultimate** goal for tough playgrounds...Double, 5/8", solid rim design • 3/16" x 1" No-Fail netlock adds to strength of goal and eliminates netlock breakage • 3/16" thick "box" design backplate and rim supports • Includes high tensile strength mounting hardware and premium nylon net • **Unconditional functional lifetime warranty.**

BA33U **Double-Rim, Heavy-Duty Flex Goal**

The industry's first double-rim flex goal...Low maintenance design can be used indoors or outdoors • 5/8" solid steel rings supported by 3/16" x 1 1/2" rim support • 15° of deflection, auto return • **Universal backplate** • No-Fail netlock system for chain, nylon or web nets • The best of breakaway and double-rim goal designs • Includes mounting hardware and nylon net • One-year limited warranty.

BA32 **Heavy-Duty Side Court and Recreational Flex Goal**

The only affordable flex goal built to take the abuse of playground, gym or home use...Simple, low-maintenance design can be used indoors or outdoors • 5/8" steel rim supported by 3/16" x 1 1/2" support • 15° deflection, auto return • Durable, orange, baked powder coated finish • Not approved for interscholastic high school or collegiate play • **Order BA35S for backboard with 5" wide x 4" high rim mounting holes** • **Universal backplate** • Includes mounting hardware and nylon net • One-year limited warranty.

BA37N **Front Mount Double-Rim Goal with No-Tie Netlocks**

Super strong, super goal...Double 5/8" steel ring for extra durability • Twelve no-tie netlocks to accept nylon net • 3/16" thick **universal backplate** • Packaged two goals per carton • Includes mounting hardware and nylon net • One-year limited warranty.

BA37 **Front Mount Double-Rim Goal**

Double rim for durability, two rim support braces for added strength...3/16" steel **universal backplate** fits all front mount boards • Bottom ring is 1/2" diameter and formed to accept either BA53 chain net (included) or BA50 premium steel net (optional) • Packaged two goals per carton • Includes mounting hardware • One-year limited warranty.

BA27A **Front Mount Super Goal**

Excellent upgrade from standard front mount goals at lower cost than double rim or breakaway goals...Full 5/8" computer designed reinforcing bar gives "super support" when player suspends from goal • Additional 5/8" brace at the vulnerable joint between rim and backplate • Continuous netlocks • 1/4" thick steel **universal backplate** • Durable, baked powder coated finish • Packaged two goals per carton • Includes mounting hardware and nylon net • Two-year limited warranty.

BA27 **Standard Front Mount Competition Goal (not shown)**

Universal backplate of 3/16" steel for mounting to virtually all boards, institutional and home...1/2" reinforcing bar, computer engineered for maximum support • Continuous netlocks • High-penetration continuous welded joints • Durable, powder coated finish • Packaged two goals per carton • Includes mounting hardware and nylon net • One-year limited warranty.

BA32RXT **FlexCourt™ Rear Mount Flex Goal**

Ideal for outdoor playgrounds or indoor courts with rear mount fan-shaped steel backboards...Same heavy-duty design as Bison BA32 front mount flex goal • Double steel die spring action • Built to absorb stress from aggressive action around the rim • Helps protect vulnerable steel backboards from damage • **Universal backplate** mounts to all rear mount backboards • Official 5/8" diameter ring • Heavy 3/16" thick rim support • Includes mounting hardware and nylon net • One-year limited warranty.

BA21A **Rear Mount Super Goal**

Stronger than other manufacturers' standard rear mount goals...1/4" continuous welded support ring for over half of the rim circumference • Continuous netlocks • Additional bracing at the backplate joint gives greater strength when player suspends from goal • 3/16" **universal backplate** mounts to all rear mount backboards • Durable powder coated finish • Packaged two goals per carton • Includes mounting hardware and nylon net • Two-year limited warranty.



800-247-7668



www.bisoninc.com

83



BA495



BA47

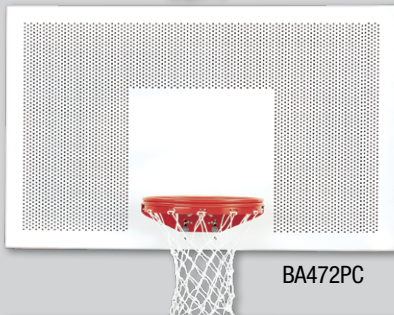

BA472PC



BA472



BA454



BA485

BA495 Fan-Shaped Dura Steel™ Backboard

Steel and lots of it highlight this 39" x 54" official size steel backboard... Superior front mount design • 12 ga. skin • 5" x 5" hole pattern • White powder coated finish • Heavy-duty mounting support structure • Standard 20" x 35" fan-type backboard mounting holes • Heaviest backboard of its type • Official orange border and shooter's square • Ten-year limited warranty.

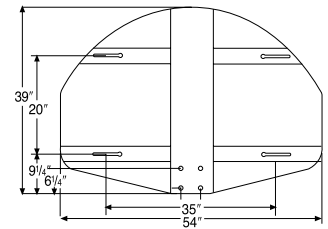

BA47 Ultimate™ Rectangular Steel Backboard

Our most popular rectangular playground backboard... 42" x 60" playing surface • Standard 20" x 35" mounting brackets allow easy attachment to any current fan-shaped ceiling or wall mounting structure • All edges safety rolled to eliminate sharp edges, increase strength and rigidity • Excellent rebound • Orange border and shooter's square • Durable white powder coated finish • Heavy-duty 12 ga. skin • 7 ga. steel support structure • 5" x 5" goal mounting hole pattern • Designed for Bison Ultimate pole structures, but will also fit most manufacturers' outdoor pole systems • Ten-year limited warranty • Lifetime limited warranty when included on a Bison Ultimate system.

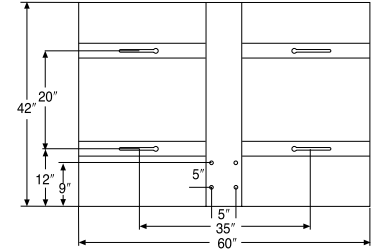

BA472PC Perforated 72" Official Size Steel Backboard

Popular style preferred for use by many inner city playgrounds... No painted-on shooter's square or border to wear off • Official 42" x 72" size • All edges on the 12 ga. skin are triple bent to eliminate sharp edges and improve rigidity and durability • Heavy tubular frame is mounted to the rear for excellent playability not found on some steel backboards • White powder coated finish • 5" x 4" goal mounting pattern • Check drawing before purchasing to mount on existing pole structures • 10-year limited warranty.

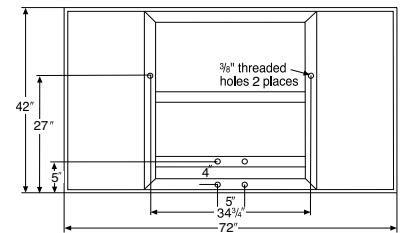

BA472 Ultimate™ Official Size Rectangular Steel Backboard

Our most popular steel backboard is now available in official 42" x 72" size... All edges safety rolled to eliminate sharp edges, increase strength and rigidity • Excellent rebound • Orange border and shooter's square • Durable white powder coated finish • Heavy-duty 12 ga. skin • 7 ga. steel support structure • 5" x 4" goal mounting hole pattern • Designed for Bison Ultimate pole structures, but will also fit Bison's 5 9/16" gooseneck and most manufacturers' outdoor pole systems • Ten-year limited warranty • Lifetime limited warranty when included on a Bison Ultimate system.

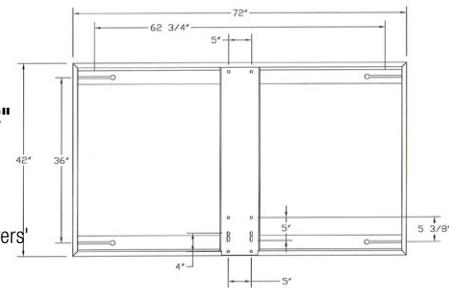

BA454 Perpetual™ Steel Backboard

Perforated shooter's square provides a permanent target that won't deteriorate... 39" x 54" rectangular backboard • 12 ga. carbon steel skin • White powder coated finish • 5" x 5" goal mounting pattern • Ten-year limited warranty.

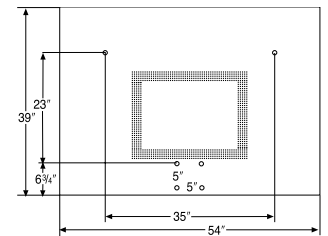

BA485 Ruff Play™ Rear Mount Steel Backboard

Replace your bent and rusty rear mount backboards... Popular rear mount goal design • Same 20" x 35" mounting structure as all rear mount backboards • 12 ga. skin • Universal goal mounting hole pattern • Recommended for replacement use only • New installations should use BA495 front mount board for maximum fan-steel durability • Extra heavy support structure • White powder coated finish • Official 35" x 54" size • Not compatible with any Bison outdoor pole systems • Five-year limited warranty.

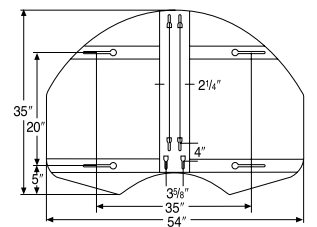

Order Goals Separately

WARNING! All backboard warranties are invalid when not mounted properly on pole systems or structure with direct rim mount supports.



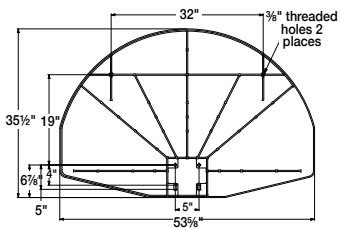

BA475SS Lifeguard™ White Aluminum Backboard With Shooter's Square

Official shooter's square and orange border on cast aluminum... White powder coated finish • Orange border and shooter's square • 5" x 5" goal mounting hole pattern • 35½" x 54"
 • Requires direct mount pole system • **Lifetime limited warranty.**



BA475SS

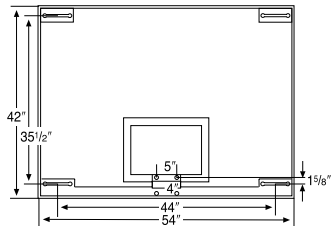

BA407G Unbreakable Glass Side Court

A scaled down version of our popular unbreakable 42" x 72" competition glass backboard... Reduced to 42" x 54" to reduce weight and cost without sacrificing features • Goal is mounted "off glass" so even excessive hanging will not cause stress • Five-year limited warranty.



BA407G

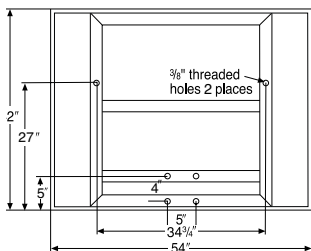

BA407U Unbreakable Polycarbonate Backboard

This backboard repels vandalism... Clear, ½" thick polycarbonate material is virtually bulletproof • Top quality appearance for outdoor systems • Extruded aluminum framework is identical to that used on our premium competition glass backboards • Powder coated steel structure absorbs stress of player contact with the goal • 42" x 54" with white shooter's square and border • **Lifetime limited warranty.**



BA407U

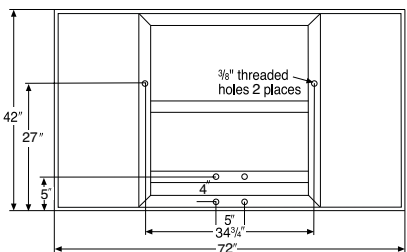

BA42UC Unbreakable 72" Official Size Polycarbonate Backboard

Clear, full sized yet bulletproof... 72" x 42" clear polycarbonate is a full ½" thick and supported by a heavy-duty aluminum frame and steel rear support structure • Looks exactly like a competition glass backboard with white shooter's square and border • Steel components have a durable powder coated finish • 5" x 4" goal mounting pattern • Check drawing before purchasing to mount on existing pole structures • **Lifetime limited warranty.**



BA42UC

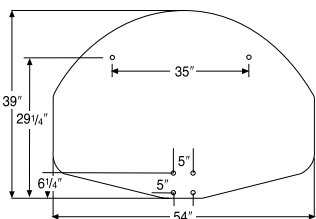

BA495P Rust-Free Polyethylene Fan-Shaped Backboard

Never worry about rusty backboards again... 39" x 54" x 1" thick polyethylene backboard • Impervious to coastal salt spray • Bright white front and back molded around orange core • Shooter's square has been machined into face to provide a permanent target not available on other poly backboards • 5" x 5" goal mounting hole pattern • Requires direct mount pole system • **Lifetime limited warranty.**



BA495P

Graffiti-Resistant

WARNING!
 All backboard warranties are invalid when not mounted properly on pole systems or structure with direct rim mount supports.

Order Goals Separately



800-247-7668



www.bisoninc.com

85

Choose a Pole System

Build your own playground basketball system...using premium Bison pole systems, backboards and rims
 • Choose from one of 11 different pole systems from 3½" to 5⁹⁄₁₆" in diameter • 36" to 96" safe play area options • Choose single sided or double sided for more efficient court utilization • Charts below will confirm which backboards and rims are compatible with which poles • **With Bison what you want is what you get.**

Pole Model Number	Diameter	Extension	Style	Bury Depth	Pole Warranty
BA780	5⁹⁄₁₆"	72"	Gooseneck Pole	48"	Lifetime
BA780XL	5⁹⁄₁₆"	96"	Gooseneck Pole	48"	Lifetime
BA777	4½"	48"	Gooseneck Pole	48"	25 Years
BA777XL	4½"	60"	Gooseneck Pole	48"	25 Years
BA775	3½"	36"	Gooseneck Pole	36"	10 Years
BA781	5⁹⁄₁₆"	72"	Adjustable Arm Pole	48"	Lifetime
BA778	4½"	48"	Adjustable Arm Pole	48"	25 Years
BA776	3½"	36"	Adjustable Arm Pole	36"	10 Years
BA781DB	5⁹⁄₁₆"	72"	Double Sided Adjustable Arm Pole	48"	Lifetime
BA778DB	4½"	48"	Double Sided Adjustable Arm Pole	48"	25 Years
BA776DB	3½"	36"	Double Sided Adjustable Arm Pole	36"	10 Years
BA781A	5⁹⁄₁₆"	72"	Arm/Braces	N/A	25 Years
BA778A	4½"	48"	Arm/Braces	N/A	2 Years
BA776A	3½"	36"	Arm/Braces	N/A	2 Years
BA77XBR	3½", 4½"	N/A	Braces Only	N/A	2 Years

Standard Gooseneck Pole shown with Optional Pole Padding

Pole + Backboard + Rim = Your Custom System

Single Sided Adjustable Arm Pole

Double Sided Adjustable Arm Pole



BA475SS

Choose a Backboard

(See pages 84-85)

Compatibility	Backboard
Compatible with all Pole Systems Above	BA495, BA475SS (shown), BA454 and BA495P
Compatible with only 4½" and 5⁹⁄₁₆" Pole Systems Above	BA47 and BA407U
Compatible with only 5⁹⁄₁₆" Pole Systems Above	BA472PC and BA42UC



BA39U

Choose a Rim

(See page 83)

Compatibility	Rims
Compatible with all Poles/Backboards and Combinations Above	BA39U (shown), BA33U, BA32, BA37, BA37N, BA27A and BA27

Outdoor **Safe Stuff™** Pole Padding

Protect players from injury caused by contact with the pole...Bison makes pole padding to fit every pole system we offer • Many styles will also fit other manufacturers' poles, refer to pole description • Hook and loop attachment straps • Thick foam covered with all-weather vinyl • One-year limited warranty • See back pages of catalog for vinyl colors and lettering options.



BA870PP-BK Shown with Optional ABC52 Lettering

Model	Fits Pole Size/Style	Padding Style	Color	Thickness	Height
BA870PP-BK	All 6" Square Poles	Fitted	Black	2"	70"
BA872PP-BK	All 4 Sides of 6" Square Poles	Fitted	Black	2"	74"
BA870JRPP	All 5" Square Poles	Fitted	Black	1"	68"
BA700PP	Any Round or Square Pole to 5 ⁹ / ₁₆ " Dia.	Wrap-Around	Black	1"	72"
BA79UPP-BK	All 4" Square Poles	Fitted	Black	1"	72"
FBCPP (see page 69)	Any Round or Square Pole to 5 ⁹ / ₁₆ " Dia.	Fitted	See Colors on page 95	5"	72"



BA700PP



Outdoor Padding Specifications

This molded DuraSkin padding is similar to that used in high schools, colleges and pro arenas across the country, but designed specifically for outdoor durability...Black padding provides protection from player contact with front and side of backboard • Fits most rectangular backboards • Bolt-on design requires backboard frame drilling • Order **BA54U-BK** for 54" wide backboards, **BA60U-BK** for 60" backboards, or **BA72U-BK** for 72" backboards • One-year limited warranty.



Outdoor Court Wall and Fence Padding

Protect players from contact with walls, fences or posts on basketball courts with outdoor durable protective padding for almost any application. Playground basketball is often an aggressive contact sport. Shouldn't players be protected just like they are in gyms? See page 37 for outdoor padding options or call a Bison protective padding specialist for assistance.





BA50

BA50 Premium Steel Playground Safety Net

This chain net will virtually eliminate the risk of loose and dangling chain links found on other chain nets...All links are welded into closed loops to eliminate separation caused when chains are stretched during play • Extra heavy-duty "S" hooks are used for attachment to any style or make of goal • Zinc plated and three times heavier than normal chain nets • Two-year limited warranty.

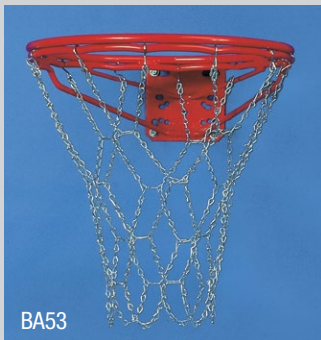

BA53

BA53 Standard Chain Net

Heavier than most other manufacturers' chain playground nets...Outperforms common nylon nets • The heavy-duty "S" hooks attach to any style of goal • This is the standard net provided with Bison BA37 goal • Zinc plating provides protection from the weather.

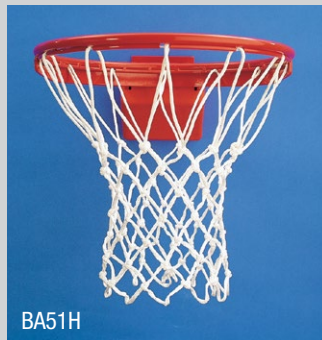

BA51H

BA51H Anti-Whip Net

Competition grade, affordable price...Heavy braided nylon to reduce net whip common with lighter weight nets • Bright white • Use for competition or as upgrade to normal residential or playground string nets.



BA56W Weld-On Repair Netlocks

A must for every park and recreation maintenance department...Low cost standard netlocks can be welded on in the shop • 12 per package.

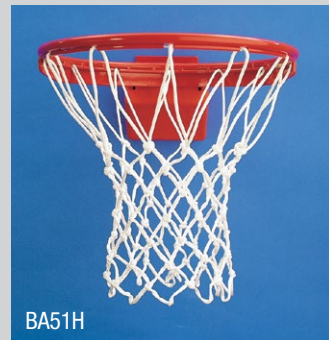

BA501H

BA501H Standard Competition Net

Heavier than nets generally supplied with goals...Braided nylon • Bright white • Excellent value.



CM200 Three-Point Reusable Steel Court Stencil

No more flimsy paper or plastic stencils that tear or blow in the wind...Easy-to-use stencil kit marks court after court with sharp straight lines • Minor cleaning of paint build up will allow stencils to last virtually forever • Kit includes 20 gauge galvanized steel stencils to paint 1½" wide base line, lane, free-throw line, top of key and official high school three-point line • Requires 2 to 3 cans of Parking Lot Spray Paint for each complete court • Stencil kit is ideal for park departments, school district maintenance departments, playground installation crews or anyone wanting a quality outdoor basketball court.



WARNING: Rim Removal and Installation By Adults Only!

Gooseneck Pole and Backboard Not Included

BA10 Replacement Shooter's Square

Ready-to-apply, official size, vinyl shooter's square will renew the look of your painted steel, wood or fiberglass backboards...Applies easily without messy adhesive or paint • Makes backboards good as new • Same heavy-duty, self-adhesive vinyl used for exterior automotive detailing • Installs in five minutes • Instructions and applicator included.



BA10

TR96 Court Protector™ Removable Goal Package

Complete with goal, bracket, hardware and removal pole to make outdoor basketball systems usable only when desired...Bison BA27 goal and nylon net can be removed from the specially designed bracket without tools or ladders using the special telescoping pole provided • If desired, goal can be locked in place using padlock (not included) • Package will retrofit to any front mount backboard that uses a 5" x 5" or 5" x 4" goal mounting hole pattern • Order **TR95** for bracket, pole and hardware (order BA27 goal with net separately) • Use with Bison 3½" and 4½" gooseneck poles only • One-year limited warranty.





HangTime™ Adjustable Basketball Systems

Hangtime adjustable home basketball systems include all the most popular features at an affordable price...6" square, 1/4" wall pole now includes a new convenient hinged base allowing easy assembly to ground level without a ladder or heavy lifting • Choose 60" clear or smoked glass or 72" clear glass backboards • Requires 2 or more adults to install.

Popular Features:

- Truglass Tempered Backboard
- EZ SwingUp Hinged Base
- 54" Safe Play Area at 10'
- 7½' - 10' Rim Height Adjustment
- Free Backboard Padding
- Free Fitted Pole Padding
- Gym Quality Heavy-Duty Breakaway Goal
- Easy-to-Read Rim Height Indicator
- Lockable Right Angle Rim Height Crank
- Textured Black Powder Coated Finish

3 Models to Choose From:

- HT6072G 42" x 72" Clear Glass Backboard
- HT6060G 36" x 60" Clear Glass Backboard
- HT6060GS 36" x 60" Smoked Glass Backboard

Now with EZ
SwingUp
Hinged Base



EZ SwingUp Base
Installation Position

EZ SwingUp Base Ready
For Play



Supplemental Installation
Video



Smooth Operating Right
Angle Crank

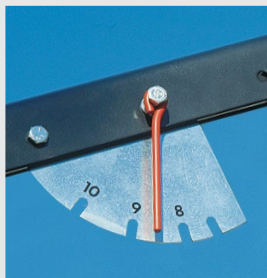

Easy to Read Rim Height Indicator



Standard Backboard Padding

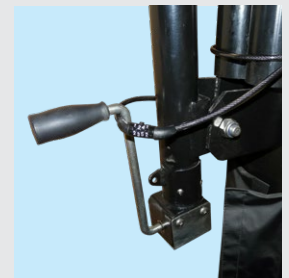

Optional Crank Lock (BALOCKHT)





4" & 5" ZipCrank™ Adjustable Basketball Systems

You'll see and feel the difference between Bison ZipCrank systems and other manufacturers' systems... Bison uses our experience as a manufacturer of competition grade equipment to offer TruGlass tempered glass backboards that give players a more realistic rebound • Every backboard has an aluminum frame much like those in the gym • The extra heavy poles and front crank style height adjustment are designed to change the height of the breakaway goal from 7½' to 10' with the turn of the removable crank handle • As an added bonus, Bison ZipCrank systems can be mounted closer to fences, walls or other obstacles than rear height adjustment systems • All systems include free fitted pole padding • Limited lifetime warranties on backboard and pole system (one-year on rim, crank and padding).

Popular Features:

- Clear TruGlass Tempered Glass Backboard
- Choose 4" or 5" Direct Bury Pole
- Removable Pedestal Base Pole Available on 5" ZipCrank
- Gymnasium Quality Heavy-Duty Competition Flex Goal
- Backboard Protecting Direct Goal Mounting
- Textured Black Powder Coated Pole Finish
- 30" Safe Play Area at 10'
- Aluminum Backboard Frame
- ZipCrank Front Crank Height Adjustment
- Removable Hand Crank Prevents Unwanted Adjustment
- Goal Height Indicator
- FREE Fitted Pole Padding
- Optional Backboard Padding
- 7½' to 10' Rim Height Adjustment

6 Models to Choose From:

- BA9350** 5" Direct Bury Pole, 36" x 60" Clear Glass Backboard
- BA9350S** 5" Direct Bury Pole, 36" x 60" Smoked Glass Backboard
- BA9350X** 5" Pedestal Base Pole, 36" x 60" Clear Glass Backboard
- BA9350SX** 5" Pedestal Base Pole, 36" x 60" Smoked Glass Backboard
- BA8350** 4" Direct Bury Pole, 36" x 54" Clear Glass Backboard
- BA8350S** 4" Direct Bury Pole, 36" x 54" Smoked Glass Backboard

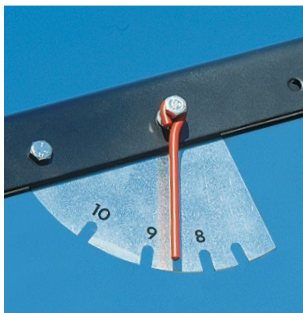

Easy to Read Rim Height Indicator



Optional Backboard Padding



Removable Ergonomic Awning Style Height Adjust Crank



Supplemental Installation Video





4" QwikChange™ Adjustable Basketball System

Hard work and dedication pay off on the court and in the design and manufacture of quality equipment as well...

Bison's 4" square QwikChange poles have 75% more steel than common round poles • One of these systems is going to look great in your driveway for years to come! • It's going to grow with your kids, too. Height adjusts from 7½' to 10' in 6" increments. • The height adjustment mechanism has over ten times the pivot contact area of commonly compared round pole systems, so go ahead and let them slam dunk! • The mounting design for the pro-style flexible goal transfers playing stress to the pole, protecting the backboard.



Easy Rim Height Adjustment

2 Models to Choose From:

BA89QC-AW 32" x 48" Clear Acrylic Backboard

BA89QC-BK 32" x 48" Smoked Acrylic Backboard



Supplemental Installation Video

Popular Features:

- 32" x 48" Backboard
- Clear or Smoked Acrylic Backboard
- **22" Safe Play Area at 10'**
- Aluminum Backboard Frame
- QwikChange Height Adjustment
- Fast Break Flex Goal
- Backboard Protecting Direct Goal Mounting
- Four Backboard Braces for Added Support
- Textured Black Powder Coated Pole Finish
- Approx. 30" Deep Bury
- **FREE** Fitted Pole Padding



BA9873



BA9488C

Ultimate™ Fixed Height Systems

Don't need rim height adjustability?...step up to the gymnasium quality of Bison's Ultimate glass basketball systems • 6" Ultimate Glass (**Model BA9873**) features a 6" square, 3/16" wall, direct bury pole, direct rim mount extension arm with a full 60" of safe play area for aggressive action, and official 42" x 72" tempered glass backboard • 5" Ultimate Glass (**Model BA9488C**) features a 5" square, 1/8" wall, direct bury pole, direct rim mount extension arm with a full 36" safe play area and a 36" x 60" • Both systems include Safe Stuff™ fitted pole padding and heavy duty outdoor breakaway goals • Each system carries a limited lifetime warranty, and will look and play great on your home court virtually forever • Optional removable base available at an additional cost.



800-247-7668



www.bisoninc.com

BACKBOARD DRAWINGS/COURT & FIELD DIAGRAMS

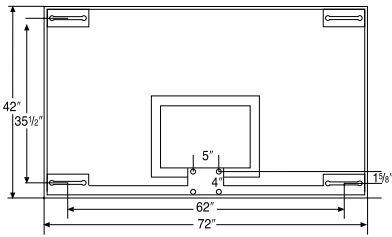

BA42XL

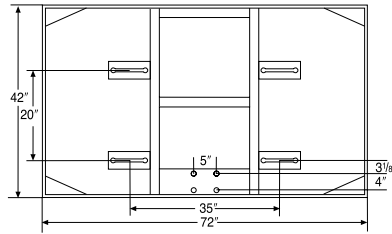

BA42XLC

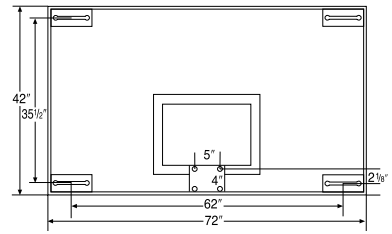

BA42E

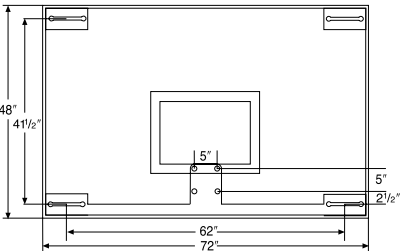

BA48XL

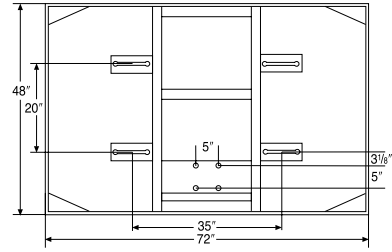

BA48XLC

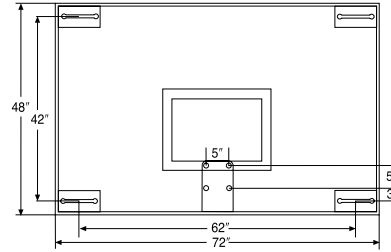

BA48

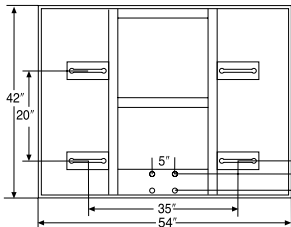

BA407C

See pages 84-85 for BA407G, BA472, and BA495 drawings.

Volleyball

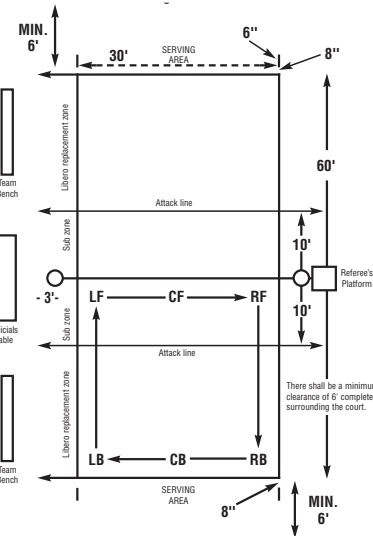

High School Basketball

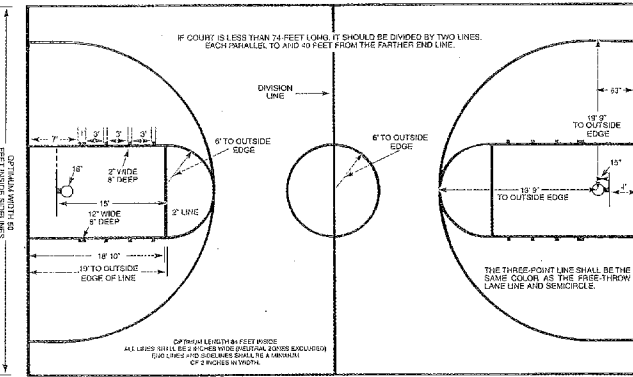

Left End Shows Rectangular Backboard 72 inches Wide

Minimum of 3 Feet Preferred: 10 feet of unobstructed space outside. If impossible to provide 3 feet, a narrow broken 1 inch line should be marked inside the court parallel with and 3 feet inside the boundary.

Right End Shows Fan Backboard 64 inches Wide

Soccer

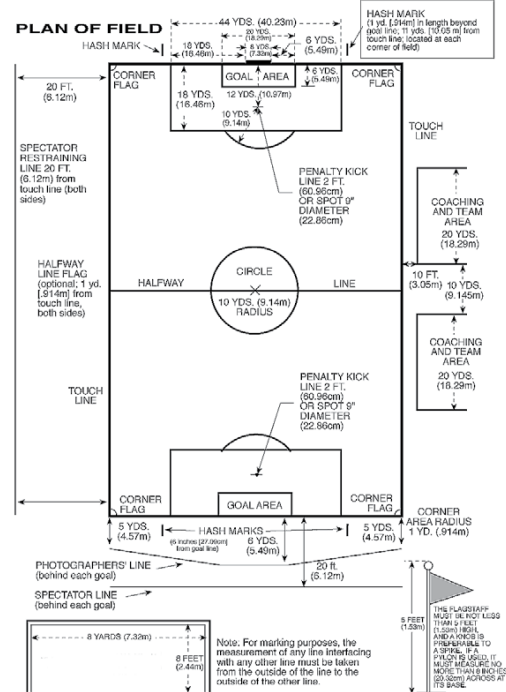

College Basketball

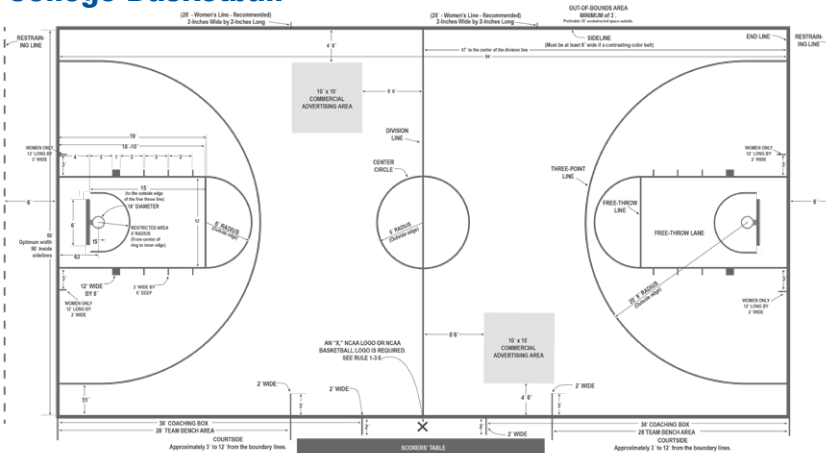

More court diagrams can be found at www.bisoninc.com/installation-info



Futsal

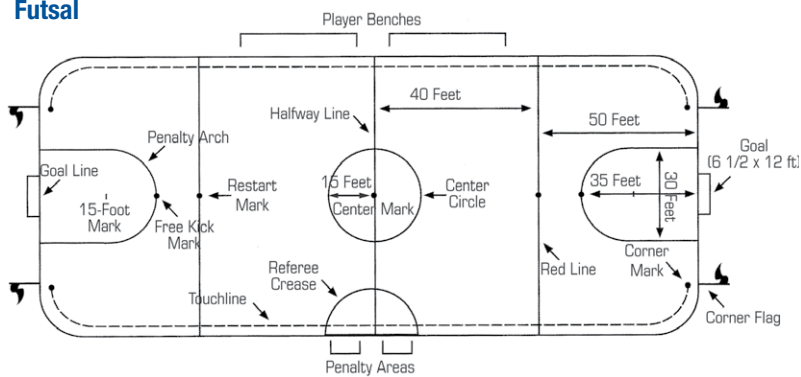

Team Handball

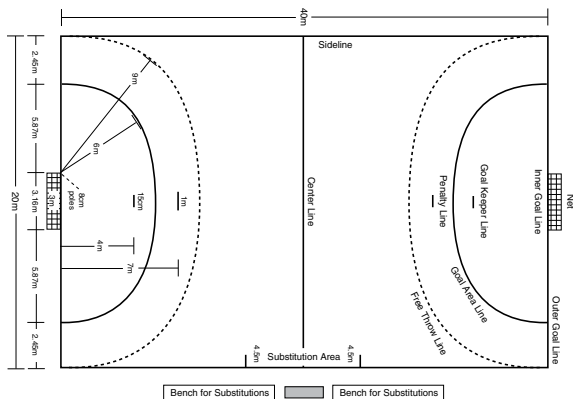

Lacrosse

Men's Lacrosse Field of Play

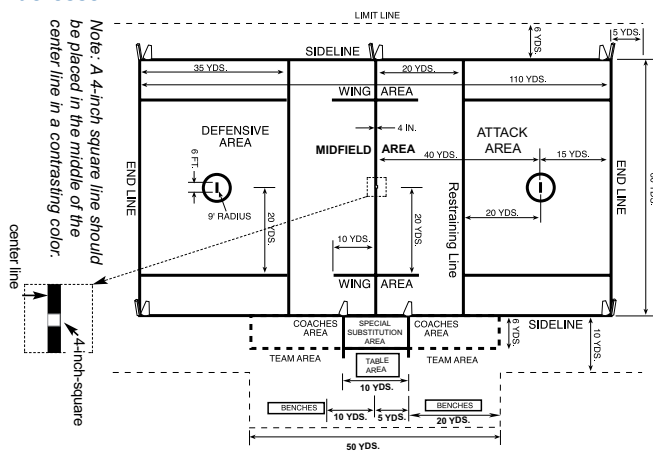

Field Hockey

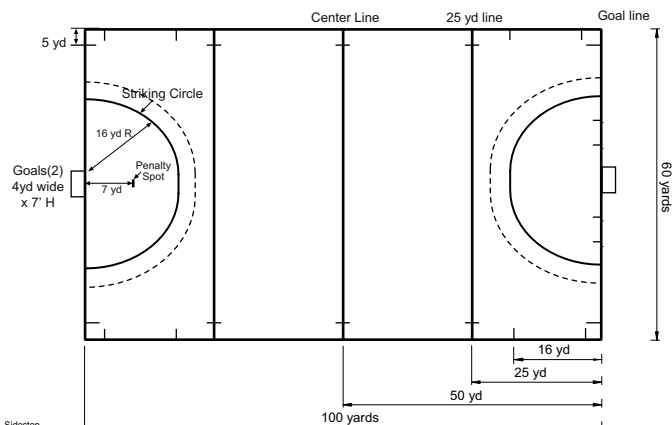

Tennis

Court should be 12 feet from sidestop and 12 feet away from other courts

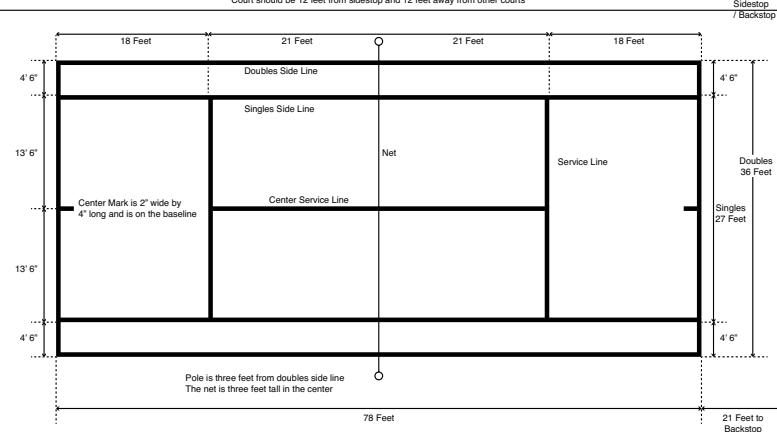

Pickleball

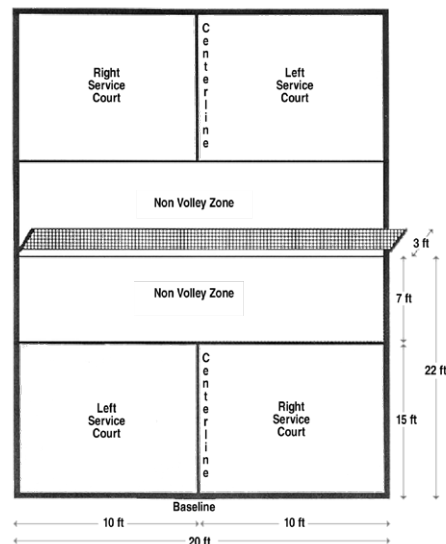

Football

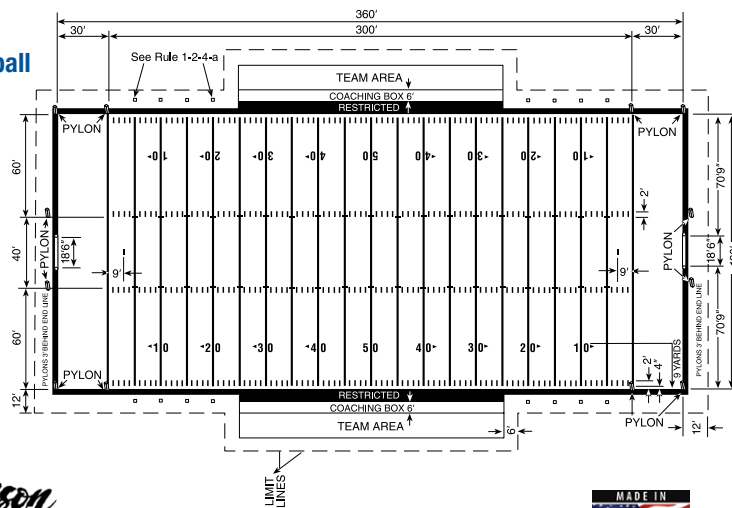

Wall Mount Structure **SAFETY WARNING!**

Due to the aggressive nature of basketball today it is likely, regardless of the level of supervision and facility rules, play will include hanging on the goal either intentionally or in the course of play. The structural failure of any component will put players or fans in danger of grave injury or even death should the structure fail. For this reason, Bison has designed all mounting brackets, hardware and structure to be of the highest quality. Your facility can feel confident installing Bison wall structures in conjunction with Bison goals, backboards and padding, assuming the safety guidelines outlined below are followed.

1. Install structure only to walls capable of supporting the load placed on the wall by the weight of the structure and the potential for additional weight of players hanging and bouncing. Generally, the further the backboard is extended from the wall the more load that is applied. Poured concrete or concrete block walls are superior. It is inadvisable to mount structure to walls with wooden or steel studs unless additional work approved by an engineer is done to provide additional support.
2. Due to the differences in wall construction, Bison does not provide the anchors to mount the wall boards to the wall. Consult a professional architect, engineer or contractor to determine safe methods for installation to your facility's walls unless you are confident in your internal facility abilities. Bison will not assume liability for the installation of any wall mount structure shown in this catalog.
3. If the wall mount structure is being installed above bleachers it is strongly recommended (but not required) by NCAA and National High School Federation rules to install a safety device similar to the Bison BA950LR Structure Catch. The BA950LR acts as a safety belt to "catch" the structure before it falls in case of failure of the wall mounting anchors or other structural components. The device mounts to the ceiling structural components.
4. It is always wise to pad the bottom of the backboard for all levels of play. NCAA and National High School Federation rules require backboard padding similar to Bison's BA68U DuraSkin for all games governed by their rules.
5. If your wall is less than 10' from the face of the backboard, it is highly recommended that the wall is padded to avoid player contact injuries. See Bison Wall Padding options on pages 32-36.
6. Always follow all installation instructions carefully. Do not omit hardware or take shortcuts.
7. Once structure is installed it is advisable to inspect annually for loose bolts as the vibration of basketball play may eventually loosen wall mount anchors and the hardware.
8. Studies have shown that 42" x 72" glass backboards reduce the risk of player injury from backboard contact. Bison manufactures 48" x 72" backboards only for replacement applications.
9. Many manufacturers now produce glass backboards that are nearly impossible to break during play. The small additional cost will provide peace of mind. See Bison BA42XL, BA44XL or BA48XL on pages 20-21.

CAUTION!

Wall mount structure requires a minimum ceiling and wall height as well as an acceptable wall mounting surface. Generally, brick or block walls are superior. It is inadvisable to mount structure to walls with wooden or steel studs unless additional work approved by an engineer is done to provide additional support. Bison does not provide wall anchors with any structure. The purchaser assumes all liability for proper selection of anchors, supporting of walls, and installation. Bison will not assume liability for the installation of any wall mounting structure shown in this catalog. Consult a professional architect, engineer or contractor to determine safe methods for installation to your facility's wall construction.

Bison Limited Warranties

All Bison products are warranted against manufacturing defects at the time of delivery. In addition, most products are covered by warranty periods stated in the description of the product. Where listed as "limited", warranties cover damage or failure that occurs during the course of "normal or intended use" of the warranted product. Normal or intended use is described as activity that is necessary for the participation in the sport for which the equipment is designed. Bison Limited Warranties do not cover any damage or failure that is the direct or indirect result of any use that is not deemed in the sole discretion of Bison to be "normal and intended use". When warranties are stated as "unconditional" or "unconditional replacement", the above stated limitations do not normally apply except in cases where damage was obviously the result of a malicious act of vandalism. Where no specific length or type of warranty is listed in the catalog, the product is warranted to be free from manufacturer's defects and for the intended purpose at the time of shipment. Whether or not stated as such, all Bison warranties allow Bison to repair or replace warranted products at Bison's sole option. Normal deterioration of products due to weather, wear and tear, or other causes that do not affect functional use are not covered by Bison warranties, regardless of type of stated warranty. All warranties are valid only when product is used in the intended application as outlined in Bison's printed literature, when installed according to Bison's instructions and when matched with compatible components as described in Bison's literature. Under no circumstances will product shown in the Residential Basketball section of this catalog be warranted for commercial or institutional use. Due to the abusive nature of pay-to-play facilities, unless specifically agreed to in writing, Bison products carry no warranty except for obvious manufacturing defects when used in a facility where players pay an individual or group fee to use Bison equipment. Bison will pay ground freight only to repair or replace defective merchandise. Unless otherwise stated, Bison will not assume any liability for labor costs incurred for removal or replacement of product replaced or repaired under warranty.

Bison Return Policy

No merchandise may be returned without prior authorization by calling 800-247-7668. Merchandise returned without a return authorization number clearly visible on the packaging will be held for no more than 10 days at which time all return credit is forfeited. Upon receipt of request for return, an authorization number will be issued by Bison and must appear on all return shipping labels. All returns must be shipped prepaid (UPS, FedEx or truck preferred) to 1100 SW 6th Street, Lincoln NE 68522. Collect returns will not be accepted.

Credit for defective merchandise will be issued only when our inspection department determines the merchandise to be covered by our warranty. All salable merchandise returned is subject to a 30% restocking charge and all freight costs with a minimum restocking charge of \$50. Due to their custom design, scoring tables and wall padding are not returnable. Sport nets are not returnable once opened.

Catalog Disclaimer

Photos and descriptions in this catalog are for reference only and are not intended to be used as technical specifications or for installation purposes. Some product photos may not exactly represent actual product shipped. Products are subject to change without notice. Any major changes in function or design will be communicated by Bison customer service if possible at time of order.



Full Color Graphic Printing Options

While it is theoretically possible to print any color with our 5-color Sport Pride graphic printing process, refer to the chart as a basic guide to color selection. Our graphic designers will work with you for a final color and design selection. Sport Pride graphic printing is available on gym and outdoor wall padding, scoring tables and some additional padding products. Inquire about custom color availability.

Colors are a computer representation and may vary from the actual colors.

*Field verify all pad/cutout measurements before releasing for fabrication. Bison is not responsible for measurement errors after an order has been released.

**Colors in art proofs do not represent actual printed/vinyl colors. Request print sample for color match if needed.



Solid Color Vinyl Padding Options

Single solid color, vinyl padding can be selected from the 18 colors at right. Product examples include: volleyball post and base padding, football post padding, T-Rex and other portable basketball padding, solid color indoor/outdoor wall padding and scoring table padding.

DR-Dark Royal	RY-Royal	SC-Scarlet	BK-Black	NY-Navy
PK-Pink	FG-Forest Green	GL-Athletic Gold	PR-Purple	MR-Maroon
OR-Orange	KL-Kelly Green	CL-Columbia Blue	GR-Gray	
BR-Brown	BO-Burnt Orange	CD-Cardinal	VG-Vegas Gold	

Note: Pink is only available on wall padding and volleyball post padding.



Lettering Colors on Padding with 1 or 2-Color Letters

Add any one color shown at right to print on solid color vinyl padding.

ABC52 Lettering Styles

A ABC **B** ABC
c ABC **D** ABC

RY-Royal	SC-Scarlet	WT-White	BK-Black
FG-Forest Green	OR-Orange	KL-Kelly Green	GL-Athletic Gold
PR-Purple	GR-Gray	NY-Navy	MR-Maroon
CL-Columbia Blue	CD-Cardinal	VG-Vegas Gold	



Ready to Apply (RTA) Adhesive Vinyl Lettering Colors

Select from vinyl colors on right to add custom lettering to ball carts, equipment carts and other powder coated steel sports equipment surfaces. See ABC92 on page 26 for details.

DR-Dark Royal	RY-Royal	NY-Navy	SC-Scarlet	WT-White
PK-Pink	BK-Black	GL-Athletic Gold	CD-Cardinal	BO-Burnt Orange
CL-Columbia Blue	BR-Brown	MR-Maroon	FG-Forest Green	OR-Orange
KL-Kelly Green	PR-Purple	MG-Metallic Gold	MS-Metallic Silver	



Color Options for Aluminum Bench and Bleacher Seats

Aluminum seats and backs can be finished in any of the colors shown at right.

RY-Royal	SC-Scarlet	NY-Navy
FG-Forest Green	BK-Black	WT-White



MODEL NUMBER INDEX WITH SHIPPING WEIGHTS

Model	Page	Weight (#)	Model	Page	Weight (#)	Model	Page	Weight (#)	Model	Page	Weight (#)
ABC50	9	NA EA	BA495P	85	62* EA	BA853GXL	10	697* EA	BALED	21	20 EA
ABC52	95	NA EA	BA50	88	4 EA	BA853UP	8, 10	NA EA	BALOCKHT	75	1 EA
ABC92	26	1 EA	BA501H	88	1 EA	BA870AXL-BK	77	20** EA	BLO7SEAT1	74	NA EA
BA10	88	1 EA	BA51H	88	1 EA	BA870JRPP	87	5** EA	BL15SEAT1	74	NA EA
BA125	26	40 EA	BA52H	24, 73	1 EA	BA870PP-BK	87	11** EA	BL21SEAT1	74	NA EA
BA165	26	70 EA	BA53	88	2 EA	BA871-BK	77, 82	494* EA	BLO702AA	72	84* EA
BA175	26	50** EA	BA54U-BK	87	6 KIT	BA871XL-BK	77, 82	529* EA	BLO703AA	72	132* EA
BA185	26	45 EA	BA56W	88	1 SET	BA872-BK	77	800* EA	BLO704AA	72	184* EA
BA187	26	45 EA	BA600YF	15	40 PR	BA872PP-BK	87	16** EA	BLO1502AA	72	154* EA
BA21A	24, 83	20 EA	BA600YR	15	60 PR	BA872XL-BK	77	564* EA	BLO1503AA	72	241* EA
BA245	26	85 EA	BA60U-BK	87	8 KIT	BA873-BK	77, 82	544* EA	BLO1504AA	72	334* EA
BA26	24	11 EA	BA658YF	15	40 PR	BA873U-BK	77, 82	476* EA	BLO2102AA	72	212* EA
BA27	24, 83	13 EA	BA658YR	15	60 PR	BA874-BK	77	491* EA	BLO2103AA	72	330* EA
BA27A	24, 83	16 EA	BA68U	16	12 KIT	BA8910IG	4	4200* EA	BLO0703AA	73	146* EA
BA3180S	22	28 EA	BA700PP	87	6 EA	BA893G	8	850* EA	BLO0703AXLAA	73	218* EA
BA3180T	22	29 EA	BA72U-BK	87	9 KIT	BA894GSR	7	1916* EA	BLO0704AA	73	204* EA
BA32	23, 83	22 EA	BA775	81, 86	103* EA	BA894USR	7	1947* EA	BLO0704AXLAA	73	310* EA
BA32S	23, 83	22 EA	BA776	86	130* EA	BA894USRO	7	1972* EA	BLO1502AA	73	166* EA
BA32RXT	23, 83	24 EA	BA776A	86	45 EA	BA895G	6	2367* EA	BLO1502AXLAA	73	229* EA
BA32XL	23	23 EA	BA776DB	86	177* EA	BA898AG	5	3473* EA	BLO1503AA	73	262* EA
BA33U	83	29 EA	BA777	80, 86	152* EA	BA898G	6	2582* EA	BLO1503AXLAA	73	400* EA
BA34	23	24 EA	BA777XL	86	161* EA	BA898GDL	9	5 EA	BLO1504AA	73	364* EA
BA35	23	24 EA	BA778	86	183* EA	BA898HD	9	4 EA	BLO1504AXLAA	73	568* EA
BA35ARC	24	1 PR	BA778A	86	67* EA	BA89QC-AW	91	146* EA	BLO2103AA	73	358* EA
BA35E	22	25 EA	BA778DB	86	253* EA	BA89QC-BK	91	146* EA	BLO2103AXLAA	73	546* EA
BA35S	23	24 EA	BA77XBR	86	12 EA	BA925LR	16	28 EA	BLO2104AA	73	496* EA
BA37	83	19 EA	BA780	79, 86	285* EA	BA930	16	16 EA	BLO2104AXLAA	73	774* EA
BA37N	83	20 EA	BA780XL	86	311* EA	BA931	14	19 EA	BM10	59	19 EA
BA39U	83	28 EA	BA781	86	340* EA	BA93250	16	1 EA	BM100	59	8 EA
BA407C	21	140* EA	BA781A	86	119* EA	BA93275	16	1 EA	BM1016	59	64 EA
BA407G	21, 85	130* EA	BA781DB	86	462* EA	BA935	16	5 EA	BM10N	12, 59	3 EA
BA407U	85	128* EA	BA79UPP-BK	87	4** EA	BA9350	90	302* EA	BM10P	59	179* EA
BA42E	21	190* EA	BA800	10	17 EA	BA9350S	90	302* EA	BM21	55, 59	5 EA
BA42UC	85	126* EA	BA800FL	10	19 EA	BA9350SX	90	311* EA	BM300A	59	3 EA
BA42XL	20	190* EA	BA801	76, 82	438* EA	BA9350X	90	311* EA	BM30-CV	55	3 EA
BA42XLC	20	187* EA	BA801BP	17, 76	9 EA	BA9488C	91	309* EA	BM350A	59	3 EA
BA44XL	21	116* EA	BA803	12	276* EA	BA950LR	16	20 EA	BM400A	59	3 EA
BA454	84	112* EA	BA803A	12	300* EA	BA973LR	16	76* EA	BNF0701AA	74	25* EA
BA47	84	143* EA	BA832	11	415* EA	BA974LR	16	86* EA	BNF0701BAA	74	46* EA
BA472	84	160* EA	BA833	11	444* EA	BA975KS	14	1 EA	BNF1501AA	74	46* EA
BA472PC	84	135* EA	BA833BLST	11	500* EA	BA980F	14	90* EA	BNF1501BAA	74	86* EA
BA475SS	85	40 EA	BA833XL	11	658* EA	BA980P	8	130* EA	BNF2101AA	74	63* EA
BA48	21	221* EA	BA8350	90	269* EA	BA980RS	14	130* EA	BNF2101BAA	74	118* EA
BA485	84	90* EA	BA8350S	90	269* EA	BA980RSE	14	146* EA	BNP0701AA	74	30* EA
BA48XL	20	221* EA	BA853A	10	643* EA	BA980RT	14	138* EA	BNP0701BAA	74	48* EA
BA48XLC	20	220* EA	BA853BLST	10	850* EA	BA980RTE	14	159* EA	BNP1501AA	74	55* EA
BA495	21, 84	98* EA	BA853G	10	682* EA	BA9873	91	555* EA	BNP1501BAA	74	89* EA

All weights listed are approximate and subject to change. They do not include additional pallets or other shipping materials.

* Ships by Truck ** Ships Small Package Oversize



MODEL NUMBER INDEX WITH SHIPPING WEIGHTS

Model.....	Page	Weight (#)	Model.....	Page	Weight (#)	Model.....	Page	Weight (#)	Model.....	Page	Weight (#)
BNP2101AA.....	74	76* EA	PK23.....	61	9 EA	PR94UZC.....	76	229* EA	SC2480PA44NT.....	63	582* PR
BNP2101BAA.....	74	89* EA	PK235.....	61	6 EA	PR95UZC.....	76	261* EA	SC2480PA44XL.....	66	642* PR
CM200.....	88	53 EA	PKG14STFS.....	18	219* EA	PR98GHT.....	75	546* EA	SC40PP.....	68	19 KIT
DN12.....	17	343* EA	PKG14STRG.....	18	331* EA	PR98GHTJR.....	75	447* EA	SC44PP.....	68	23 KIT
DN1250.....	17	701* EA	PKG250.....	19	88** EA	PR98SHT.....	75	525* EA	SC44S.....	67	7 EA
DN25.....	17	20 EA	PKG275.....	19	101** EA	PR98SHTJR.....	75	475* EA	SC500.....	30	4 EA
DN50.....	17	15 EA	PKG300.....	19	210* EA	PR98SXLHT.....	75	590* EA	SC50B.....	65, 68, 71	3 EA
FB10EXT.....	69	62* Kit	PKG46SFRG.....	13	442* EA	PR98UHT.....	75	486* EA	SC72NC.....	68	2 PKG
FB45HS.....	69	1040* PR	PKG46STRG.....	13	441* EA	PR98UHTJR.....	75	411* EA	SCBKT2.....	9	44 EA
FB45S.....	69	124* EA	PKG48STFS.....	18	295* EA	SC03PP.....	71	.6#/Kit	SCBKT6.....	9	23 EA
FB55CG.....	69	1014* PR	PKG48STRG.....	18	413* EA	SC045N.....	68	5 PR	SCFUTSAL.....	71	192* PR
FB55HS.....	69	1202* PR	PKG500.....	18	272* EA	SC04GA.....	68	5 Set/4	SCFUTSALN.....	71	8 PR
FB55S.....	69	129* EA	PKG600.....	18	248* EA	SC04WK.....	68	65 Set/4	SCNOTIP.....	68	50 PR
FB58CG.....	69	1064* PR	PKG650.....	18	310* EA	SC050N.....	68	6 PR	SCTEAMHB.....	71	186* PR
FB58HS.....	69	1252* PR	PKG675.....	18	357* EA	SC060N.....	68	14 PR	SHCLK200.....	9	25/SET
FBCPP.....	69, 87	18** EA	PKG68SFRG.....	13	487* EA	SC06CF.....	68	8 Set/4	ST125F.....	29	475* EA
FBCPPG.....	69	18** EA	PKG68STRG.....	13	464* EA	SC06CFW.....	68	12 Set/4	ST84F.....	30	124* EA
FBWDS.....	69	2 Set/2	PKG82SFRG.....	13	579* EA	SC06DK.....	68	1 Set	ST85B.....	29	360* EA
FH200.....	70	291* PR	PKG82STRG.....	13	542* EA	SC072N.....	68	17 PR	ST85F.....	29	315* EA
FH200N.....	70	30 PR	PR12.....	76	163* EA	SC080N.....	68	12 PR	ST85FI.....	28	392* EA
FH200WK.....	70	37 Set/4 EA	PR15.....	78	254* EA	SC0945IGA.....	67	193* PR	STC036.....	31	119* EA
HTADPT.....	75	33 EA	PR17.....	78	338* EA	SC0945PA30E.....	65	238* PR	STC100.....	31	1 EA
HT6060G.....	89	466* EA	PR18.....	78	268* EA	SC10.....	68	4 EA	STC300S.....	31	8 EA
HT6060GS.....	89	466* EA	PR20.....	81	214* EA	SC100N.....	68	23 PR	STC500CONN.....	31	1 EA
HT6072G.....	89	566* EA	PR29.....	81	156* EA	SC106N.....	68	22 PR	STC500S.....	31	18 EA
LC050N.....	70	26 PR	PR31.....	81	228* EA	SC1265IGA.....	67	336* PR	STCART.....	31	N/A EA
LC200.....	70	198* PR	PR33.....	81	164* EA	SC1265PA30E.....	65	248* PR	SUCBLFT.....	16	0.1 FT
OFC4234.....	15	223* EA	PR52.....	80	220* EA	SC1865IGA.....	67	418* PR	SVB08.....	12, 58	3 EA
OFC4235E.....	15	223* EA	PR52XL.....	80	229* EA	SC1865PA30E.....	65	364* PR	SVB10.....	57	89* PR
OFS4234.....	15	226* EA	PR55.....	80	278* EA	SC1865PA40E.....	64	427* PR	SVB100.....	57	51* EA
OFS4834.....	15	233* EA	PR55XL.....	80	287* EA	SC1865PA40NT.....	63	448* PR	SVB1000.....	57	258* EA
OFX423180.....	15	229* EA	PR60.....	80	323* EA	SC1865PA44E.....	64	461* PR	SVB1002.....	57	401* EA
OFX4235E.....	15	225* EA	PR60XL.....	80	332* EA	SC1865PA44NT.....	63	482* PR	SVB1250K.....	53, 57	11 EA
OFX483180.....	15	262* EA	PR70.....	80	302* EA	SC2170IGA.....	67	435* PR	SVB2000A.....	58	90* EA
OFX4835E.....	15	258* EA	PR70G.....	80	307* EA	SC2170PA30E.....	65	375* PR	SVB210.....	58	21 EA
PB050.....	12	13 EA	PR70XL.....	80	311* EA	SC2170PA40E.....	64	520* EA	SVB26.....	57	10 EA
PB100BP.....	12	7 EA	PR74.....	79	437* EA	SC2170PA40NT.....	63	541* PR	SVB27.....	57	62 EA
PB130.....	12	199* EA	PR75.....	79	353* EA	SC2170PA44E.....	64	480* PR	SVB28.....	57	27 EA
PB150BB.....	12	7 EA	PR75XL.....	79	379* EA	SC2170PA44NT.....	63	501* PR	SVB500A.....	58	62* EA
PK05XL.....	61	80 EA	PR76.....	79	411* EA	SC2480IGA.....	67	460* PR	SVB5000A.....	58	138* EA
PK10.....	61	15 EA	PR77.....	79	456* EA	SC2480IGAFB.....	67	696* PR	SVB5050A.....	58	115* EA
PK10CS.....	61	4 EA	PR77XL.....	79	482* EA	SC2480PA30E.....	65	453* PR	SVB5050W.....	51	59** EA
PK10N.....	61	3 EA	PR78.....	79	439* EA	SC2480PA40E.....	64	525* PR	SVB73.....	57	93* EA
PK10NXL.....	61	12 EA	PR79.....	79	452* EA	SC2480PA40EURO.....	66	677* PR	TB100.....	59	25 EA
PK10P.....	61	174* EA	PR79XL.....	79	478* EA	SC2480PA40NT.....	63	546* PR	TB100GS.....	59	2 EA
PK10XL.....	61	55 EA	PR87.....	79	492* EA	SC2480PA44E.....	64	561* PR	TB100P.....	59	23 EA
PK21.....	61	5 EA	PR87XL.....	79	518* EA	SC2480PA44FB.....	67	818* PR	TB200.....	59	37 EA

All weights listed are approximate and subject to change. They do not include additional pallets or other shipping materials.

* Ships by Truck ** Ships Small Package Oversize



800-247-7668



www.bisoninc.com

97

MODEL NUMBER INDEX WITH SHIPPING WEIGHTS

Model	Page	Weight (#)	Model	Page	Weight (#)	Model	Page	Weight (#)	Model	Page	Weight (#)
TB200GS	59	2 EA	VB13	53	3 PR	VB510P	52	10 EA	VB9140	51	11 EA
TB200P	59	35 EA	VB13SL	53	1 PR	VB51P	52	20 PR	VB92	51	7 Set
TB300	59	201* EA	VB17	53	10 PR	VB51PG	52	20 PR	VB94	51	84** EA
TB50-B	59	2 EA	VB20	42	123* PR	VB51PGUP	52	NA EA	VB96	51	87 EA
TN05	60	85 EA	VB200	42	60* EA	VB51PL	52	18 PR	VB98HG	53	1 EA
TN10	60	60 EA	VB2000	42	170* EA	VB60	46	92* PR	VBDSS	56	2 EA
TN10CS	60	1 EA	VB2000NS	42	152* EA	VB600	46	61* EA	VBTBASE	50	30 EA
TN10N	60	15 EA	VB2002	42	250* EA	VB6000	46	136* EA	VBTBASEP	50	8 EA
TN10NP	60	14 EA	VB2002NS	42	220* EA	VB6000NS	46	118* EA	VBHOOK/LOOP	54	1 PR
TN10P	60	207* EA	VB21	55, 58	6 EA	VB6000T	50	218* EA	WP2NGFW	36	3 SQFT
TN23	60	9 EA	VB22	55	7 EA	VB6002	46	228* EA	WP2NGJW	36	3 SQFT
TN235	60	6 EA	VB23	55	9 EA	VB6002NS	46	201* EA	WP2NGVS	36	3 SQFT
TR70RP	24	6 EA	VB230	56	23 EA	VB600C	46	65* EA	WP2NGVW	36	3 SQFT
TR74	24	2 EA	VB235	55	6 EA	VB6050	46	113* EA	WP2NGZW	36	3 SQFT
TR75	24	12 EA	VB23CH	55	7 EA	VB6050NS	46	101* EA	WP2NSFW	36	3 SQFT
TR76	24	4 EA	VB23CH-CV	55	4 EA	VB60C	46	106* EA	WP2NSJW	36	3 SQFT
TR86	25	49 EA	VB23-CV	55	6 EA	VB60W	54	5 EA	WP2NSVS	36	3 SQFT
TR95	88	8 EA	VB23IK	56	7 EA	VB70	44	82* PR	WP2NSVW	36	3 SQFT
TR96	88	21 EA	VB23IKRB	56	1 EA	VB700	44	50* EA	WP2NSZW	36	3 SQFT
VB10	40	89* PR	VB23LK	55	9 EA	VB7000	44	129* EA	WP2UGFW	36	2.2 SQFT
VB10C	40	100* PR	VB23LK-CV	55	6 EA	VB7000NS	44	111* EA	WP2UGJW	36	2.2 SQFT
VB10T	48	80* PR	VB23ST	55	10 EA	VB7002	44	213* EA	WP2UGVS	36	2.2 SQFT
VB100	40	55* EA	VB24	55	5 EA	VB7002NS	44	186* EA	WP2UGVW	36	2.2 SQFT
VB1000	40	142* EA	VB25	50, 56	2 EA	VB72	43	53* PR	WP2UGZW	36	2.2 SQFT
VB1000NS	40	124* EA	VB25FL	50, 56	3 EA	VB7202	43	171* EA	WP2USFW	36	2.2 SQFT
VB1000T	50	210* EA	VB25TF	50, 56	2 EA	VB7202NS	43	144* EA	WP2USJW	36	2.2 SQFT
VB1002	40	225* EA	VB26	55	9 EA	VB722	43	37* EA	WP2USVS	36	2.2 SQFT
VB1002NS	40	198* EA	VB26CH	55	7 EA	VB7222	43	100* EA	WP2USVW	36	2.2 SQFT
VB100C	40	55* EA	VB26LK	55	9 EA	VB7222NS	43	82* EA	WP2USZW	36	2.2 SQFT
VB100T	48	50* EA	VB26ST	55	10 EA	VB73A	54	94* EA	WP466-BK	32	10 Set/4
VB10W30	54	6 EA	VB27	55	10 EA	VB76	54	104* EA	WP62UF	36	0.5 LIN.FT
VB10W35	54	6 EA	VB27CH	55	8 EA	VB80JR	48	2600* PR	WP62UZ	36	0.5 LIN.FT
VB11	41	99* EA	VB27LK	55	10 EA	VB810	47, 48	568* EA	WP62NF	36	0.5 LIN.FT
VB110	41	60* EA	VB30	45	62* PR	VB8100	47, 48	2870* EA	WP62NZ	36	0.5 LIN.FT
VB1100	41	146* EA	VB300	45	52* EA	VB8100JR	47, 48	2750* EA	WPRAIL	37	0.5 LIN.FT
VB1100NS	41	128* EA	VB3000	45	109* EA	VB8102	47	3500* EA	WPRAIL200	37	NA LIN.FT
VB1102	41	240* EA	VB3000NS	45	91* EA	VB8102DJ	47	3650* EA	WPRAIL238	37	NA LIN.FT
VB1102NS	41	213* EA	VB3002	45	195* EA	VB8102JR	48	3350* EA	WPRAIL350	37	NA LIN.FT
VB1200RR	54	1 Set/4	VB3002NS	45	168* EA	VB810BASE	48	500* EA	WPRAIL450	37	NA LIN.FT
VB123	53	1 EA	VB335	56	3 EA	VB810JR	48	570* EA	WPRAILCT	37	1 Set/100
VB1250K	53	12 EA	VB340	56	5 EA	VB810P	48	52 EA	WPUP2HD	36	1 SQFT
VB1250KRR	54	1 EA	VB340F	56	5 EA	VB82	49	684* PR	WPUP3N	36	0.4 SQFT
VB1250KU	53	9 EA	VB3530	56	19 EA	VB8200	49	792* PR	WPUP3U	36	0.4 SQFT
VB1250SP	52	3 EA	VB354	56	6 EA	VB8250	49	803* PR	WPUPFRC	36	NA SQFT
VB1250ST	52	5 PR	VB35P	54	2 SET	VB82P	49	NA PR	WPUPVONAR	36	0.1 SQFT
VB1250TR	52	5 EA	VB4030	56	15 EA	VB9130	51	7 EA	WPZ3	36	1 LIN, FT
VB1253W	54	53 EA	VB4035	56	15 EA	VB9135	51	9 EA			

All weights listed are approximate and subject to change. They do not include additional pallets or other shipping materials.

* Ships by Truck ** Ships Small Package Oversize





Nick Cusick
President
402-474-3353



Chris Livingston
Sales Manager
402-817-1293

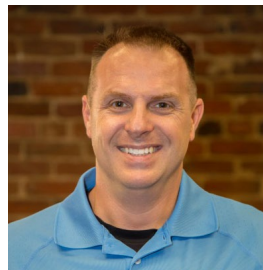

Nik Ditzler
Director, Specified Products
402-817-4572

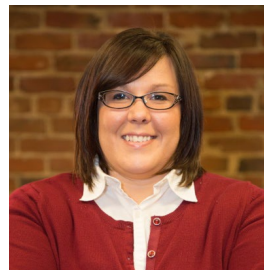

Kelly Bouwens
Product Specialist &
Traffic Coordinator
402-817-1732



Matt Duchek
Graphic Product Specialist
402-817-3703

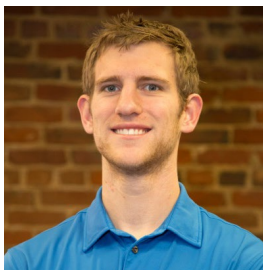

Zach Grove
Product Specialist
402-858-4649



Tyce Lilienthal
Product Specialist
402-858-4765



Hayes Oswald
Product Specialist
402-817-1346



Carrie Hoyt
Accounts Receivable
402-817-1315



Lee Ramirez
International Sales Agent
708-835-5026

Sales Reps



Ken Hunt
(NE, IA)
Lincoln, NE
C: 402.770.5676
khunt1@neb.rr.com



Dave Gignac
(MI, OH)
Davisburg, MI
P: 248.625.8326
F: 248.625.3469
dgignac.basales@gmail.com



Chris Hellenkamp
(NC, VA, WV)
Cary, NC
P: 919.481.2594
F: 919.460.1023
C: 919.345.2544
chrishellenkamp@yahoo.com



Tommy Wilson
(So.TX, So.LA)
Houston, TX
F: 832.328.8440
C: 205.792.1500
tommywilson03@aol.com



Steve Schwabe
(IL, IN)
Moline, IL
P: 309.235.2764
F: 309.788.2685
Schwabesteve@gmail.com



David Mollica
(CT, MA, VT, NH, ME)
Stratham, NH
P: 603.319.1792
C: 603.204.4548
Email: dave@ne6sales.com



Derreck Cole
(GA, SC, TN, KY)
Cumming, GA
P/C: 770.331.6143
F: 678.828.5997
bamawabbit67@yahoo.com



Scott Anderson
(OK, AR)
Goldsby, OK
F: 405.288.3317
C: 405.795.2600
scotta2525@aol.com



Mark Roekle
(MN, WI, ND, SD)
Eau Claire, WI
C: 715.829.6401
mroekle@aol.com



Todd Kausrud
(CA, NV, HI, AZ, NM)
Norco, CA
C: 909.851.1103
todd.kausrud@verizon.net



Eric Bell
(FL)
Oviedo, FL
F: 321.235.1131
C: 321.663.3680
ebell90@yahoo.com



Greg Hunt
(KS, MO)
Olathe, KS
F: 913.273.0229
C: 913.526.4124
greg.hunt@sbcglobal.net



Bill Greig
(NJ)
Neptune, NJ
P: 908.217.6540
C: 908.217.6540
billgreig@verizon.net

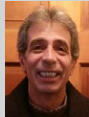

Jay Nero
(NY, PA, MD, DE)
Tonawanda, NY
P: 716.694.3713
F: 716.694.3298
C: 716.308.9260
jnero30935@aol.com



Monte Robertson
(No.TX, No. LA)
Corinth, TX
P: 940.321.7903
F: 940.497.0111
C: 940.367.5228
mhrob57@charter.net



John Brady
(ID, MT, UT)
Boise, ID
P: 208.867.4412
F: 208.939.7476
johnbrady@cableone.net



Maxie Kizzire
(AL, MS, TN, KY)
Tuscaloosa, AL
F: 205.758.9922
C: 205.792.1500
maxie2304@aol.com





603 L Street
Lincoln, NE 68508

800-247-7668
www.bisoninc.com



20M/9-21

KEY PLAYERS ARE BEATING THE BALLS

A GOAL FOR EVERY GAME

SALES EQUIPMENT